

TRIM-LOK[®] INC.

TRIMS AND SEALS
Since 1971



FEATURED PRODUCTS

Trim-Seal
Pages 18-20

Co-Extruded
Trim-Seal
Page 21

Rubber-Seal
Pages 30-36

Custom Rubber
Extrusion
Capabilities
Page 43

Our products use
3M Attachment Tapes

Decimal and Millimeter Equivalent

INCHES			DECIMALS	MILLIMETERS
1/8"	1/16"	1/32"	.01562	0.3968
		3/64"	.04687	1.19062
	3/16"	5/64"	.07812	1.98437
		3/32"	.09375	2.38125
		7/64"	.10937	2.77812
1/4"	3/8"	9/64"	.14062	3.57187
		5/32"	.15625	3.96875
	1/2"	11/64"	.17187	4.36562
		13/64"	.20312	5.15937
		7/32"	.21875	5.55625
3/8"	7/8"	15/64"	.23437	5.95312
		1/4"	.250	6.3499
	1 1/8"	17/64"	.2656	6.7467
		9/32"	.2812	7.1436
		19/64"	.2968	7.5405
1/2"	1 1/4"	5/16"	.3125	7.9374
		21/64"	.3281	8.3342
	1 3/8"	11/32"	.3437	8.7311
		23/64"	.3593	9.1280
		3/8"	.375	9.5249
5/8"	1 7/8"	25/64"	.3906	9.9217
		13/32"	.4062	10.7154
	2"	27/64"	.4220	10.3186
		7/16"	.4375	11.1124
		29/64"	.4531	11.5092
1 1/4"	2 1/8"	15/32"	.4687	11.9061
		31/64"	.4843	12.3029
	2 1/2"	1/2"	.500	12.6998
		33/64"	.5156	13.0967
		17/32"	.5312	13.4936
1 3/4"	3 1/8"	35/64"	.5468	13.8904
		9/16"	.5625	14.2873
	3 1/2"	37/64"	.5781	14.6841
		19/32"	.5937	15.0811
		39/64"	.6093	15.4779
1 7/8"	4 1/8"	5/8"	.625	15.8748
		41/64"	.6406	16.2716
	4 1/2"	21/32"	.6562	16.6685
		43/64"	.6718	17.0654
		11/16"	.6875	17.4623
2"	4 3/4"	45/64"	.7031	17.8591
		23/32"	.7187	18.2560
	5"	47/64"	.7343	18.6528
		3/4"	.750	19.0498
		49/64"	.7656	19.4466
2 1/4"	5 1/8"	25/32"	.7812	19.8435
		51/64"	.7968	20.2403
	5 1/2"	13/16"	.8125	20.6373
		53/64"	.8281	21.0341
		27/32"	.8437	21.4310
2 3/4"	6"	55/64"	.8593	21.8278
		7/8"	.875	22.2247
	3"	57/64"	.8906	22.6215
		29/32"	.9062	23.0185
		59/64"	.9218	23.4153
3 1/4"	6 1/2"	15/16"	.9375	23.8122
		61/64"	.9531	24.2090
	7"	31/32"	.9687	24.6060
		63/64"	.9843	25.0028
		1"	1.000	25.3997

1-888-874-6565





TRIM-LOK INC.
www.trimlok.com

TABLE OF CONTENTS

EDGE TRIMS

EDGE TRIM	4-9	
FIRE RETARDANT TRIM . . .	10	
RUBBER-LOK	11	
EDGE-GUARD	12	
DECORATIVE TRIM	13	
RUBBER EDGE TRIM	14-15	
SEWABLE UPHOLSTERY TRIM	16	
J-CLIPS	16-17	

TRIM SEALS

TRIM-SEAL	18-20	
CO-EXTRUDED TRIM-SEAL..	21	
HATCH SEAL	22	
FLAP SEAL	23	

DESIGN ASSISTANCE

UTILIZING THE RIGHT MATERIAL	42
--------------------------------------	----

PLASTIC PROFILES

LIP GUARD	24	
DRIP RAIL	25	
CARPET TRIM	25	
REDI-STIK	26	
RV SNAP-IN SEAL	27	
RV APPLICATIONS	28-29	

SEALS

RUBBER-SEAL	30-36	
FENDER FLARE TRIM	34	
TUBING AND CORD	36	
LOCKING GASKET	38-39	

TOOLS AND DESIGN ASSISTANCE

PACKAGING OPTIONS	37
TOOLS AND ACCESSORIES	40-41
ADHESIVE OPTIONS	42
ADDITIONAL CAPABILITIES	43

EDGE TRIM

EDGE TRIMS

Individual Metal Clips Retain a Permanent Grip

Edge Trim is a flexible PVC trim with individual internal metal clips and gripping tongues to provide a stronger grip.

Strong Gripping Tongue

Many Applications

- Sharp Edges
- Trucks
- Boats
- Forklifts
- Golf Carts
- Helmets
- Truck Cabs
- Fiberglass
- Computer Cabinets
- Tractor Cabs
- Riding Mowers
- Machinery Guards
- Sheet Metal
- Playground Equipment
- And Many More



Check out our **How to Install video** at: www.edge-trim-install.info

OVER 50 YEARS OF



QUALITY & EXPERIENCE



FLEXIBLE AND EASY TO INSTALL!

TRIM-LOK INC.
1-888-874-6565
www.trimlok.com

EDGE TRIM

EDGE TRIMS

1 TRIM EDGE THICKNESS					2	3	4	
1/64"	1/32"	1/16"	3/32"	1/8"	Trim Series	Trim Color	Texture	Clip
 62-1/64	 62-1/32	 62-1/16	 62-3/32		62 Series	White	Coarse Sand	Alum.
						Black	Pebble Sand	
See page 7 for "How to Order" Instructions	 75-1/32	 75-1/16	 75-3/32	 75-1/8	75 Series	White	Coarse Sand	Alum.
						Black	Pebble Sand	
						Light Grey	Coarse	
	 750-1/32	 750-1/16	 750-3/32	 750-1/8	750 Series	Black	Leather	Alum.

Product Specifications:
Recommended temperature rating for general applications: -20°F. through +158°F.

Outer Coating Material:
Vinyl (PVC), Hardness: 85 Durometer (Shore A)

Internal Clip Material:
Aluminum or Steel

Flammability & Code Compliance:
Vinyl: FMVSS 302
FAA/FAR 23.853
UL 50
UL 844



FILE# MH49032



EDGE TRIM

1 TRIM EDGE THICKNESS

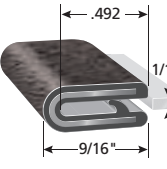
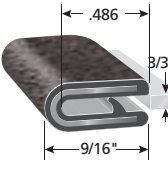
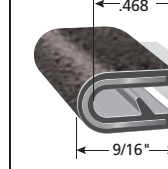
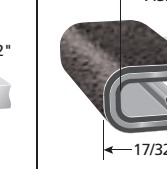
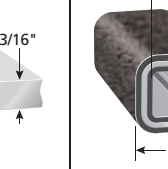
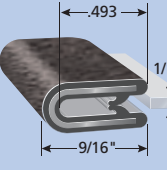
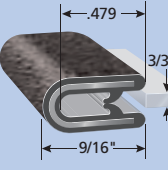
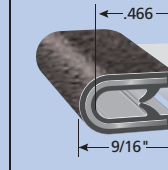
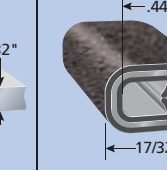
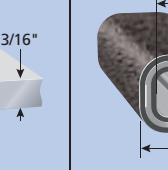
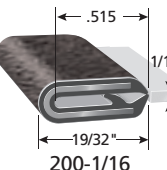
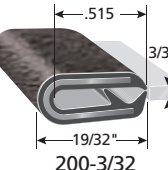
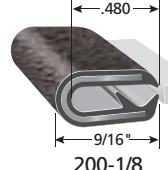
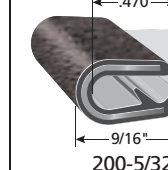
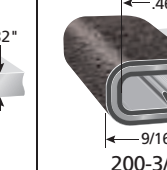
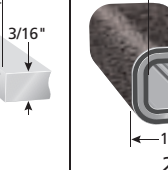
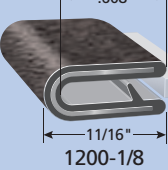
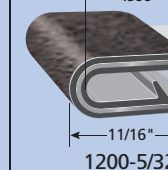
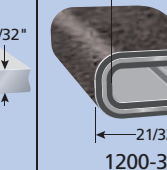
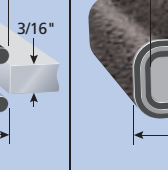
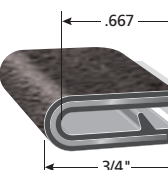
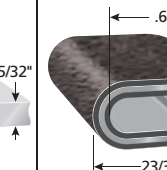
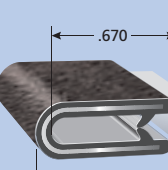
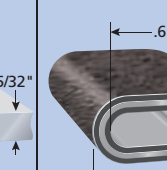
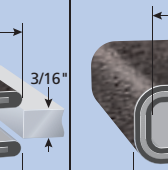
1/16"	3/32"	1/8"	5/32"	3/16"	1/4"
0.063"	0.094"	0.125"	0.156"	0.188"	0.250"
 <p>100-1/16</p>	 <p>100-3/32</p>	 <p>100-1/8</p>	 <p>100-5/32</p>	 <p>100-3/16</p>	 <p>100-1/4</p>
 <p>150-1/16</p>	 <p>150-3/32</p>	 <p>150-1/8</p>	 <p>150-5/32</p>	 <p>150-3/16</p>	 <p>150-1/4</p>
 <p>200-1/16</p>	 <p>200-3/32</p>	 <p>200-1/8</p>	 <p>200-5/32</p>	 <p>200-3/16</p>	 <p>200-1/4</p>
 <p>1200-1/8</p>	 <p>1200-5/32</p>	 <p>1200-3/16</p>	 <p>1200-1/4</p>		
 <p>1375-1/8</p>	 <p>1375-5/32</p>	 <p>1375-3/16</p>	 <p>1375-1/4</p>		
 <p>1350-1/8</p>	 <p>1350-5/32</p>	 <p>1350-3/16</p>	 <p>1350-1/4</p>		



EDGE TRIMS

EDGE TRIM

EDGE TRIMS

	5/16"	3/8"	1/2"		2	3	4	
	0.313"	0.375"	0.500"		Trim Series	Trim Color	Texture	Clip

HOW TO ORDER

1 Determine edge **THICKNESS** of your material. Use column 1.
 Measure thickness 

2 Select **TRIM SERIES**. Determine how far trim is to be inserted. Use column 2.

3 Select available **COLOR**. Use column 3.

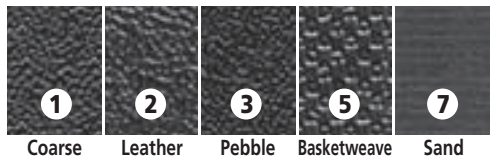
4 Select type of **TEXTURE**. Use column 4.

Determine **ORDER QUANTITY** in 250 foot increments. 5,000 feet minimum for custom colors.

Part Number Example **2** **3** **4** **1**
750 **B** **2** **X1/32**

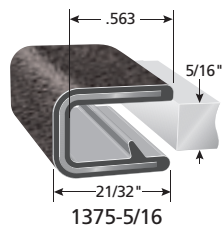
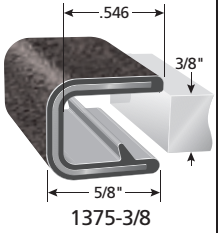
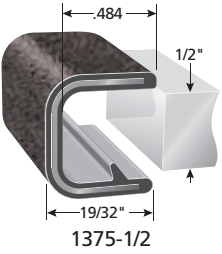

 1375-5/16	 1375-3/8	 1375-1/2		1375 Series	Black Grey Light Beige Light Grey Tan White	Pebble Sand Sand Pebble Pebble Pebble Pebble Sand	Alum.
--	---	---	--	--------------------	--	--	-------

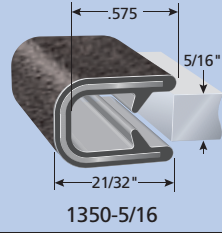
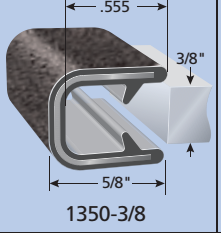
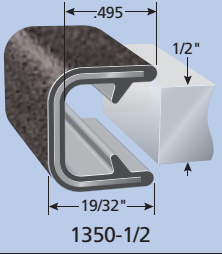
 1350-5/16	 1350-3/8	 1350-1/2		1350 Series	Black White	Leather Leather	Alum.
--	---	---	--	--------------------	----------------	--------------------	-------

Edge Trims continued next page

EDGE TRIM

EDGE TRIMS

1 TRIM EDGE THICKNESS

1/2"	5/8"	3/4"	2	3	4	5
0.500"	0.625"	0.750"	Trim Series	Trim Color	Texture	Clip
			2000 Series		Jumbo Trim	
				Black	Pebble	Steel
				White	Pebble	

Jumbo Trim is a flexible PVC trim with individual internal metal clips and gripping tongue to provide a stronger grip.

HOW TO ORDER

1

Determine edge **THICKNESS** of your material. Use column 1.



2

Select **TRIM SERIES**

Determine how far trim is to be inserted. Use column 2.

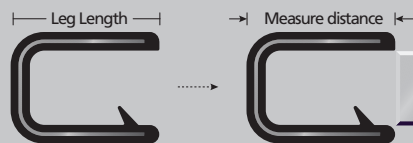

3

Select available **COLOR**. Use column 3.

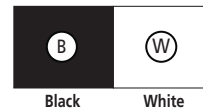

4

Available **TEXTURE** is PEBBLE. Use column 4.

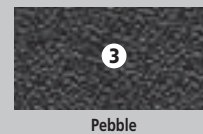

5

Available **CLIP MATERIAL** is STEEL. Use column 5.

Part Number Example

2 5 3 4 1
2000 S B 3 X1/2

90° Miter Tool

Part# GSS851

See pages 40-41

Cuts in seconds.

DESIGNED TO FIT A RANGE OF SIZES



Trim Series	SIZE RANGE	COLOR	TEXTURE	CLIP	PART NO.
	FITS MATERIAL THICKNESSES FROM 0.010" TO 0.030"	Black	Pebble	Steel	1630SB3-1581
	FITS MATERIAL THICKNESSES FROM 0.010" TO 0.050"	Black	Pebble	Steel	1620SB3-341
		White	Pebble	Steel	1620SW3-342
	FITS MATERIAL THICKNESSES FROM 0.032" TO 0.125"	Black	Basket Weave	Steel	1600SB5-315
		Black	Pebble	Steel	1600SB3-317
		White	Pebble	Aluminum	1600B3-317
	FITS MATERIAL THICKNESSES FROM 0.085" TO 0.210"	Black	Basket Weave	Steel	1645SB5-336
		White	Pebble	Steel	1645SW3-337
		Black	Pebble	Steel	1645SB3-338
	FITS MATERIAL THICKNESSES FROM 0.090" TO 0.190"	White	Pebble	Steel	1640SW3-331
		Black	Pebble	Steel	1640SB3-708
	FITS MATERIAL THICKNESSES FROM 0.090" TO 0.190"	Black	Pebble	Steel	1650SB3-339
		Black	Pebble	Aluminum	1650B3-339
	FITS MATERIAL THICKNESSES FROM 0.135" TO 0.250"	Black	Pebble	Steel	1610SB3-343
		Black	Pebble	Aluminum	1610B3-343
		White	Pebble	Steel	1610SW3-344
	FITS MATERIAL THICKNESSES FROM 0.250" TO 0.500"	Black	Pebble	Steel	1660SB3-349
		White	Pebble	Steel	1660SW3-1628

FIRE RETARDANT TRIM

Fire Retardant Trim is a flexible trim with metal clips to provide a permanent grip. It is manufactured out of a Thermoplastic Elastomer (TPE) material formulated to pass the National Fire Protection Agency (NFPA) standards.

EDGE TRIMS

1 TRIM EDGE THICKNESS				2	3	4	
1/8"	5/32"	3/16"	1/4"	Trim Series	Trim Color	Texture	Clip
0.125"	0.156"	0.188"	0.250"				
<p>100-1/8</p>	<p>100-5/32</p>	<p>100-3/16</p>	<p>100-1/4</p>	100 Series	Black	Pebble	Alum.
					White	Pebble	
<p>1375-1/8</p>	<p>1375-5/32</p>	<p>1375-3/16</p>	<p>1375-1/4</p>	1375 Series	Black	Pebble	Alum.
					White	Pebble	

• UL94VO compliant vinyl available by special request only (reference Trim-Lok Material #VY0117)

Ask about our REFLECTO-LOK EDGE TRIM with reflective tape

Product Specifications:

Recommended temperature rating for general applications: -20°F. through +158°F.

Base Material:

(TPE) Thermoplastic Elastomer, Hardness: 80 Durometer (Shore A)

Internal Clip Material:

Aluminum

Flammability and Code Compliance:

UL 94 HB
NF PA 1971

HOW TO ORDER

- Determine edge **THICKNESS** of your material. Use column 1.
Measure thickness
- Select **TRIM SERIES**
Determine how far trim is to be inserted. Use column 2.
Leg Length → Measure distance ←
- Select available **COLOR**. Using column 3.

Black White
- Select type of **TEXTURE**. Use column 4.

Pebble

Part Number Example **100** **B** **3** TPRFR **X1/4**



RUBBER-LOK

Rubber-Lok simulates rubber and individual internal metal clips provide a secure grip.

Many Applications

- Boat Consoles
- ATV's
- Helmets
- Utility Trailers
- Truck Bodies
- Automobiles
- Sheet Metal Products
- And Many More

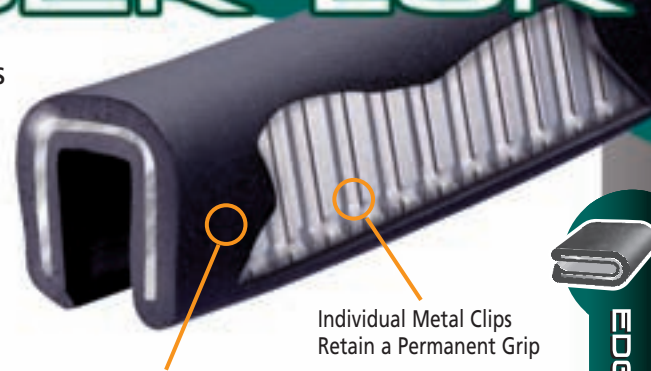

Black PVC Plastic that Offers a 'Rubber' Look and Feel

Individual Metal Clips Retain a Permanent Grip



RUBBER-LOK SERIES-THICKNESS

1/16"	3/32"	1/8"	3/16"	1/4"	
0.063	0.094	0.125	0.188	0.250	
1100 Series					
					Alum.
1100B7X1/16	1100B7X3/32	1100B7X1/8	1100B7X3/16	1100B7X1/4	
2200 Series					
					Steel
2200SB7X1/16	2200SB7X3/32	2200SB7X1/8	2200SB7X3/16	2200SB7X1/4	

Custom Materials:

Rubber-Lok can be ordered in special compounds based upon your specific application requirements.

Custom Colors:

Rubber-Lok can be ordered in custom colors to match your special needs. You can also highlight your trim with special decorative finishes.

Custom Profiles:

Special shapes or modifications to Rubber-Lok can be developed in order to meet your needs.

Custom Length:

Rubber-Lok can be ordered in specific cut lengths. Minimum quantities apply.

Product Specifications:

Recommended temperature rating for general applications: -20°F. through +158°F.

Base Material:

Vinyl (PVC), Hardness: 85 Durometer (Shore A)

Internal Clip Material:

Aluminum or Steel



EDGE-GUARD

EDGE TRIMS



Decorative Mylar

Clear Plastic

Hot Melt Adhesive

Edge-Guard is a pre-glued, flexible plastic trim with a mylar or clear cover. It gives a beautiful, finished appearance.

Many Applications

- Car Door Edges
- Furniture
- Vending Machines
- Running Boards
- Fender Flares

Product Specifications:

Recommended temperature rating for general applications: -20°F. through +158°F.

Base Material:

Vinyl (PVC), Hardness: 97 Durometer A
Decorative Finish: Mylar Overlay
White, Hardness: 88A Durometer

Adhesive:

Hot Melt Adhesive
Optional Butyl Adhesive Sealant

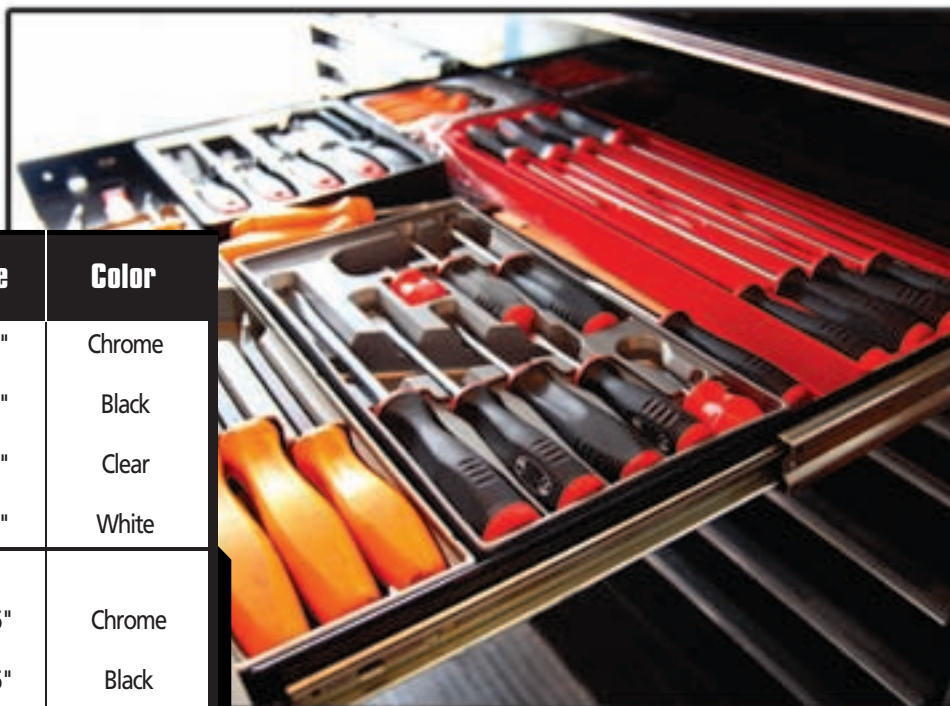

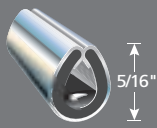
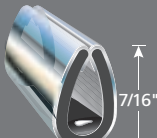
Edge-Guard®	Part No.	Size	Color
 <p>Fits over edges up to 1/8"</p>	EGC	5/16"	Chrome
	EGB	5/16"	Black
	EGCL	5/16"	Clear
	EGW	5/16"	White
 <p>Fits over edges up to 3/16"</p>	EGC7/16	7/16"	Chrome
	EGB7/16	7/16"	Black

DECORATIVE TRIM

Decorative Trim is a flexible PVC trim with chrome finish.

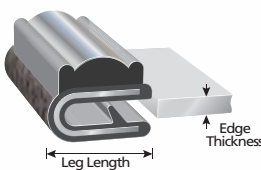
1 Finish	2 Trim Series	3 Trim Color	4 Texture	Profile (Approx. full size)	5 Edge Thickness	Leg Length	Internal Clip	Part Number Example
8=Chrome	100 Series	White	Coarse Pebble Sand		1/16"	9/16"	Alum.	8100B3X1/8
		Black	Pebble Sand		3/32"	9/16"		
		Tan	Coarse Pebble Sand		1/8"	9/16"		
					5/32"	9/16"		
					3/16"	17/32"		
					1/4"	1/2"		



EDGE TRIMS

Decorative Trim-Seal

is a flexible PVC trim with a decorative finish. It can be supplied with or without an EPDM sponge rubber bulb to provide a secure seal for a variety of applications.

Product Specifications:
Recommended temperature rating for general applications: -20°F. through +158°F.

Outer Coating Material:
Vinyl (PVC), Hardness: 85 Durometer (Shore A)

Internal Clip Material:
Aluminum

Flammability & Code Compliance:

Vinyl: FMVSS 302
FAA/FAR 23.853
UL 50E
UL 94HB

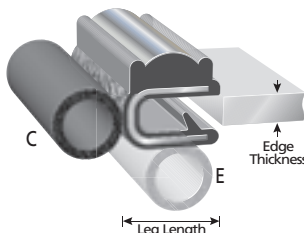
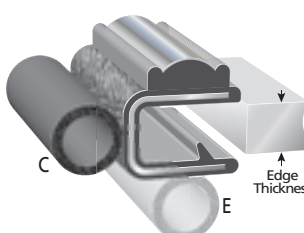
1 Finish	2 Trim Series	3 Trim Color	4 Texture	5 Profile	6 Edge Thickness	Leg Length	7 Bulb Location	Internal Clip	Part Number Example
8=Chrome	100 Series	White	Coarse Pebble Sand		1/16"	9/16"	C	Alum.	1 Finish 2 Bulb Size 3 Trim Series 4 Trim Color 5 Texture 6 Edge Thickness 7 Bulb Location
		Black	Pebble Sand		3/32"	9/16"			
		Tan	Coarse Pebble Sand		1/8"	9/16"			
					5/32"	9/16"			
					3/16"	17/32"			
					1/4"	1/2"			
8=Chrome	375 Series	White	Pebble Sand		1/8"	3/4"	C	Alum.	
		Black	Pebble Sand		5/32"	3/4"			
		Tan	Pebble Sand		1/4"	11/16"			
					5/16"	21/32"			
					3/8"	5/8"			
					1/2"	19/32"			

2 Bulb Sizes Available

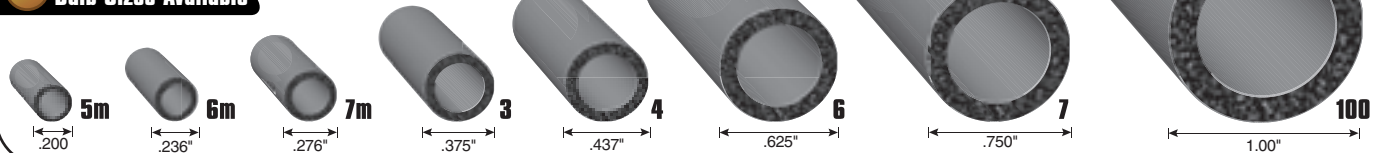

These parts may require minimum orders and longer lead times.

RUBBER EDGE TRIM

EDGE TRIMS



Rubber Edge Trims are available in either **EPDM** or **Neoprene**, these two different materials are designed to fit your application perfectly.

Neoprene is a well proven proprietary blend that weathers well, has very good resistance to abrasion, flex cracking, alkalis, and acids and is best used in applications where flame resistance is a requirement. This material has moderate resistance to oils and gasoline. Neoprene is generally considered an excellent all-purpose material with a solid balance of properties and few limitations. However, expect poor resistance to aromatic and oxygenated solvents and limited flexibility at low temperatures. Hardness:70 Durometer (Shore A) Service temperature ranges from -40°F. to 225°F.

EPDM has excellent performance characteristics. EPDM (Ethylene-Propylene-Diene-Monomer) is best known for its excellent ozone, weathering, and aging resistance. It also has excellent water and steam resistance, maintains its flexibility at low temperatures, features excellent resistance to alkalis, acids, and oxygenated solvents, and is very color stable. It is not recommended for resistance to oil, gasoline, and hydrocarbon solvents. EPDM is found in a wide range of applications and is excellent for use outdoors.

Hardness: 70 Durometer (Shore A)
Service temperature range per spec and per vendor from -40°F. to 212°F. for EPDM and Neoprene.
Short term is -40°F. to 225°F.

Butyl Sealant can be ordered pre-applied and provides excellent sealing characteristic with good heat performance.

Service temperature ranges from -20°F. to 158°F.
Hot Melt Adhesive can be ordered pre-applied and to provide a stronger grip with good heat performance.

Recommended temperature rating from -20°F. to 158°F.
FMVSS 302

RUBBER EDGE TRIM-THICKNESS

1/32"	1/16"	1/16"	1/8"
0.032	0.063	0.063	0.125
No glue available in this column			
<p>X1001</p>	<p>X1002</p>	<p>X2017</p>	<p>X1003</p>
<p>X1010</p>	<p>X1011</p>		<p>X1012</p>
<p>X2001</p>	<p>X2002</p>	<p>X2073</p>	<p>X2003</p>
<p>X2012</p>	<p>X2013</p>	<p>X2008</p>	<p>X2014</p>
<p>X2059</p>	<p>X2010</p>		<p>X2102</p>
	<p>X2009</p>		<p>X2006</p>



RUBBER EDGE TRIM

EDGE TRIMS

3/16"	1/4"	5/16"	3/8"
0.188	0.250	0.313	0.375
<p>X1004</p>	<p>X1005</p>	<p>X1006</p>	<p>X1007</p>
<p>X1013</p>	<p>X1014</p>	<p>X1015</p>	<p>X1016</p>
<p>X2004</p>	<p>1/8</p> <p>0.125</p> <p>X2060</p>	<p>1/2"</p> <p>0.500</p> <p>X1018</p>	<p>3/4"</p> <p>0.750</p> <p>X2007</p>
<p>X2015</p>			
<p>X2011</p>			

HOW TO ORDER

<p style="text-align: center;">Neoprene Part# Example</p> <p>X1001 WG</p> <p>WG= with glue WB= with pre-applied butyl sealant</p> <p>— Rubber Edge Trim profile</p>	<p style="text-align: center;">EPDM Part# Example</p> <p>X1001 E WG</p> <p>WG= with glue WB= with pre-applied butyl sealant E=EPDM</p> <p>— Rubber Edge Trim profile</p>
---	--



J-CLIP AND SEWABLE UPHOLSTERY TRIM

EDGE TRIMS

Upholstery Trims and J-Clips

are manufactured out of a sewable non-break material. Fabric can be sewn to these parts and used to keep the material tight to the seat frame once in place.

Upholstery Trim is sewn to leather seat cover to attach to seat frame

UPHOLSTERY TRIM

Product Specifications:

Recommended temperature rating for general applications: -20°F. through +158°F.

Outer Coating Material:

Vinyl (PVC), Non-break. Hardness: 85 Durometer (Shore A)

Internal Clip Material: Aluminum

Profile	Part No.	Color
	529B3X1/8	Black
	529CC036-3X1/8	Gray
	529CC037-3X1/8	Taupe

Custom colors available. Minimums apply.

J-CLIPS

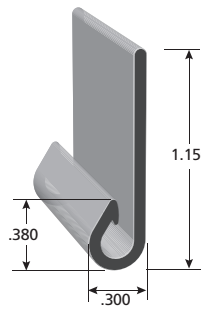

I11026

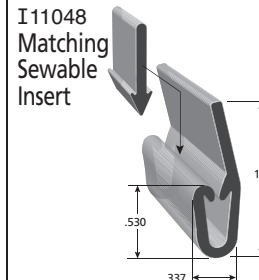

I11038

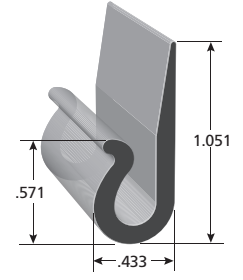

I11023

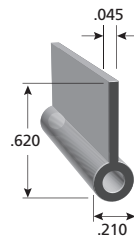

I11053

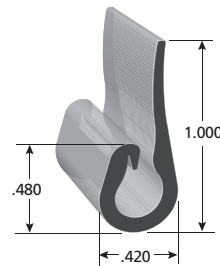

I11109

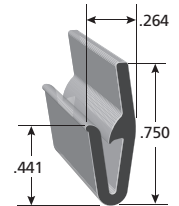

I11102

Product Specifications:

Recommended temperature rating for general applications: -20°F. through +158°F.

Material:

Polypropylene, Non-break. Hardness: 90 Durometer (Shore A)

J-CLIP AND SEWABLE UPHOLSTERY TRIM

J-CLIPS

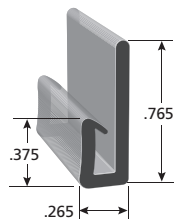

I11114

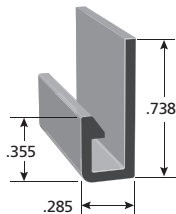

I11099

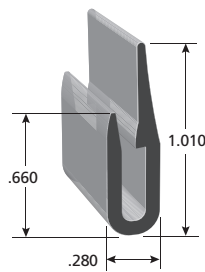

I11107

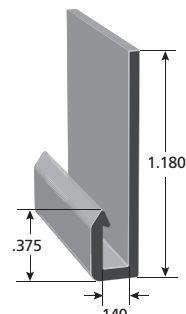

I11039

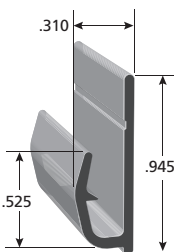

I11103

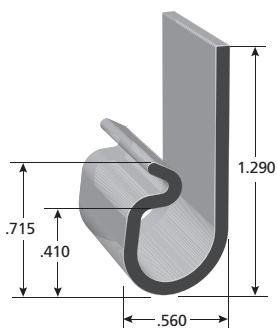

I11108

I11059
Matching
Sewable
Insert

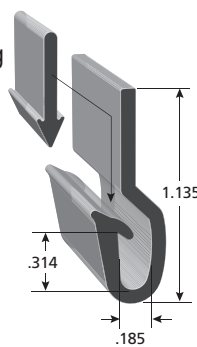

I11060

I11071
Matching
Sewable
Insert

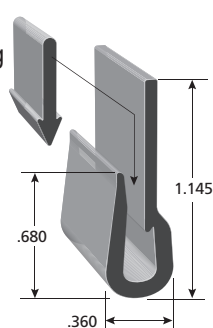

I11072

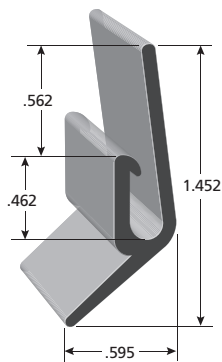

I11105

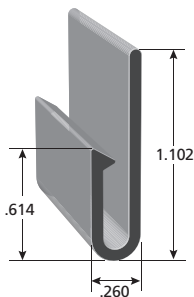

I11024



TRIM SEAL



Seals and Protects against Weather Damage!

Trim Seal is a flexible PVC Trim with a sponge rubber bulb seal attached to provide a secure seal for a variety of applications.

Check out our **How to Install video** at: www.trim-seal-install.info



Product Specifications:
 Recommended temperature rating for general applications: -20°F. through +158°F.
Outer Coating Material:
 Vinyl (PVC), Hardness: 85 Durometer (Shore A)

Internal Clip Material:
 Aluminum or Steel
Flammability & Code Compliance:
 Vinyl: FMVSS 302
 FAA/FAR 23.853
 UL 50E
 UL 94HB



FILE# MH49032

HOW TO ORDER

Determine **BULB COLOR**

OW Off White B Black = No callout necessary

Determine **BULB SIZE** based on closed distance between door and jam.
 1.5 x Closed dimension = **BULB SIZE** needed.
 (Example: Closed dimension is .50 then 1.50 x .50 = .75 Bulb Dia.)

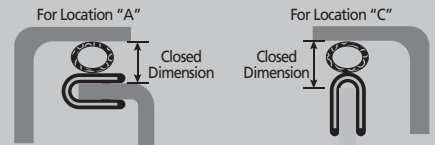

Select **TRIM SERIES**

Determine how far trim is to be inserted.

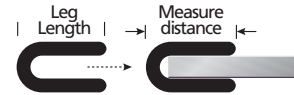

Determine **TRIM COLOR** to best suit application



Determine **TEXTURE** to best suit application

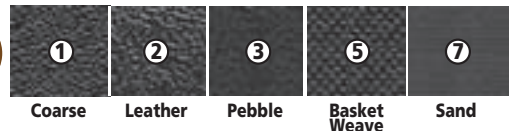

Determine edge **THICKNESS**

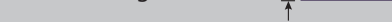

Select **BULB LOCATION** best to suit.

Typical Applications











* A-B or D-E non-standard location, special order, non-returnable

Part Number Example

OW 1 2 3 4 5 6
 OW 3 100 B 3 X1/8 A

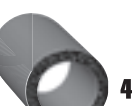
Many Applications

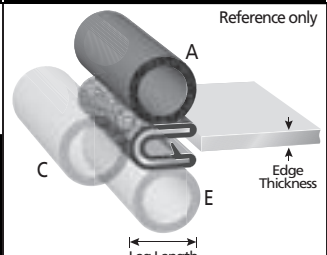
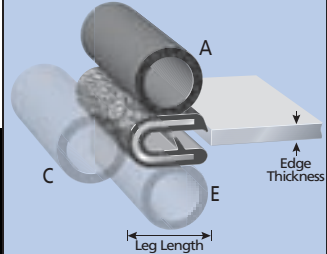
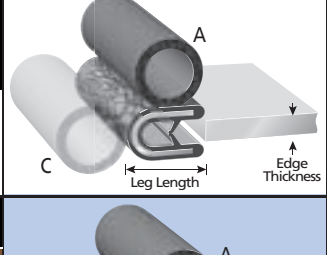
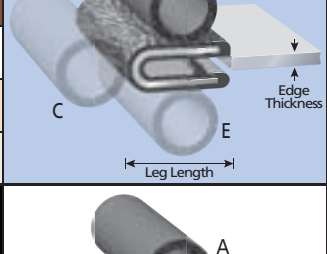
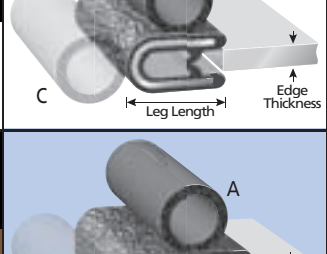
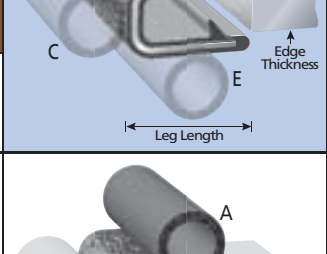
- Boat Hatch Seals
- RV Compartments
- Door Seals
- Tonneau Cover Seals
- Tool Box Seals
- Many More

1	2	3	4	5	6	Internal Clip	Part Number Example	
Bulb Sizes Available	Trim Series	Trim Color	Texture	Profile (Approx. full size)	Edge Thickness	Leg Length	Bulb Location	
 5m  6m  7m  3  4  6  7  100	062 Series	White Black	Coarse Pebble Sand Pebble Sand		1/64" 1/32" 1/16" 3/32"	3/8" 3/8" 3/8" 3/8"	A C E	Alum. 7m 062 B 3 X 1/64 A Bulb Size (1) Trim Series (2) Trim Color (3) Texture (4) Edge Thickness (5) Bulb Location (6)
	075 Series	White Black	Coarse Pebble Sand Pebble Sand		1/32" 1/16" 3/32" 1/8"	7/16" 7/16" 7/16" 7/16"	A C E	Alum. 4075B3X1/32A
	750 Series	Black White	Leather Coarse Pebble Sand		1/32" 1/16" 3/32" 1/8"	7/16" 7/16" 7/16" 7/16"	A C	Alum. 3750B2X1/16A
	100 Series	Black Tan White Light Biege Light Grey	Pebble Sand Coarse Pebble Sand Leather Pebble Coarse Pebble		1/32" 1/16" 3/32" 1/8" 5/32" 3/16" 1/4"	37/62" 9/16" 9/16" 9/16" 9/16" 17/32" 1/2"	A C E	Alum. Steel 6100B3X1/8EWB
	150 Series	Black White	Leather Sand Leather		1/32" 1/16" 3/32" 1/8" 5/32" 3/16" 1/4"	37/62" 9/16" 9/16" 9/16" 9/16" 17/32" 1/2"	A C	Alum. 7150B2X5/32A
	1375 Series	Black Tan White	Pebble Sand Pebble Pebble Sand		1/8" 5/32" 3/16" 1/4" 5/16" 3/8" 1/2"	3/4" 3/4" 3/4" 11/16" 21/32" 5/8" 19/32"	A C E	Alum. 4375B3X3/8C 4375 B 3 X 3/8 C W B Bulb Size (1) Trim Series (2) Trim Color (3) Texture (4) Edge Thickness (5) Bulb Location (6) Butyl Adhesive
	1350 Series	White Black	Leather Leather		1/8" 5/32" 3/16" 1/4" 5/16" 3/8" 1/2"	3/4" 3/4" 3/4" 11/16" 21/32" 5/8" 19/32"	A C	Alum. 4350B2X1/2A



TRIM SEALS

TRIM-SEAL

1 Bulb Size	2 Trim Series	3 Trim Color	4 Texture	Jumbo Trim-Seal Profile (Approx. full size)	5 Edge Thickness	Leg (Fixed size)	6 Bulb Location	Internal Clip	Part Number Example		
5m	2000 Series	White	Pebble		1/2"	1"	A		1 Bulb Size 2 Trim Series 3 Trim Color 7 2000 S B 3 X 3/4 A Texture 4 Edge Thickness 5 Bulb Location 6 See page 19 for bulb size illustrations		
6m											
7m											
3		Black	Pebble				5/8"	15/16"		C	Steel
4											
6											
7											
100	Tan	Pebble			3/4"	7/8"	E				

See page 18 for
"How to Order" Instructions.

Additional Trim-Seal

Combine any of our stock Rubber Seals with our standard Edge Trim to achieve the perfect Trim-Seal combination for your application. Longer lead times and minimums may apply.

<p>103B375B3X3/16E</p>	<p>113B100B3X1/8E</p>	<p>1333B100B3X1/8E</p>	<p>3B150B2X1/8A</p>
<p>1B150B2X1/8C</p>	<p>105B100B3X1/8A</p>	<p>109B375B3X3/16E</p>	<p>202B100B3X1/8E</p>
<p>135B375B3X3/16E</p>	<p>See page 18 for "How to Order" Instructions.</p> <p>Check with your Trim-Lok sales representative for additional bulb size options.</p>		

CO-EXTRUDED TRIM-SEAL

Product Specifications:

Recommended temperature rating for general applications: -40°F. through +212°F.

▲ = ALUMINUM WIRE CARRIER

● = STEEL WIRE CARRIER

<p>▲ DDA1501 EPDM Dense</p> <p>Clamping Range .039 - .099</p>	<p>▲ DD1201 EPDM Dense</p> <p>Clamping Range .050 - .090</p>	<p>▲ DD6112 EPDM Dense</p>	<p>● DD6138 EPDM Dense</p> <p>Clamping Range .060 - .125</p>
<p>▲ DD6114 EPDM Dense</p> <p>Clamping Range .060 - .125</p>	<p>▲ DD6131 EPDM Dense</p> <p>Clamping Range .060 - .125</p>	<p>● DD6139 EPDM Dense</p> <p>Clamping Range .060 - .125</p>	<p>● DD6126 EPDM Dense</p> <p>Clamping Range .050 - .100</p>
<p>● DDA3229</p> <p>Clamping Range .039 - .157</p>	<p>● DD1004</p> <p>Clamping Range .050 - .125</p>	<p>▲ DD6100</p> <p>Clamping Range .080 - .120</p>	<p>● DD6118</p> <p>Fits Edge .125</p>
<p>● DDA1503</p> <p>Clamping Range .039 - .138</p>	<p>● DD6130</p> <p>Clamping Range .063 - .187</p>	<p>▲ DD6125 ● DD1614-002</p> <p>Clamping Range .030 - .063</p>	<p>▲ DDA2513</p> <p>Clamping Range .040 - .118</p>
<p>▲ DDA2518</p> <p>Clamping Range .039 - .078</p>	<p>▲ DDA1549</p> <p>Clamping Range .030 - .060</p>	<p>▲ DD6123</p> <p>Clamping Range .039 - .079</p>	<p>● DD1013</p> <p>Clamping Range .090 - .125</p>

CO-EXTRUDED

HATCH SEAL

Resists kinks in a radiused corner

Durable PVC Plastic Trim

EPDM Sponge Rubber Bulb

Tear Resistant

Individual Metal Clips Retain a Permanent Grip

Hatch Seal is a specially formulated compound rubber that provides a watertight seal and prevents leaks.

Recommended temperature rating for general applications: -20°F. through +158°F.

1 Bulb Size	2 Trim Series	3 Trim Color	4 Texture	Profile (Approx. full size)	5 Edge Thickness	Leg Length	6 Bulb Location	Example Part Number
	100 Series	Black	Pebble Sand		1/16"	9/16"	A	1 Bulb Size 2 Trim Series 3 Trim Color 12B100B7X3/16A
					3/32"	9/16"		
					1/8"	9/16"	E	Texture 4 Edge Thickness 5 Bulb Location 6
					3/16"	17/32"		
					1/4"	1/2"		
					3/16"	17/32"	C	
					1/4"	1/2"		

See page 18 for "How to Order" Instructions.

FOR A WATER TIGHT SEAL!



Typical Application

- Greater tear strength
- Protects against weathering
- Wide range of sizes to fit precisely
- Reduces noise and vibrations
- Optional butyl adhesive sealant for a stronger grip and to prevent seepage into storage compartment

1-888-874-6565
TRIM-LOK INC.
 www.trimlok.com

FLAP SEAL

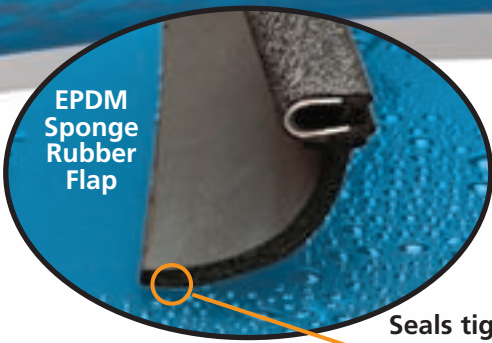

Seals tight to protect against weather damage

Durable PVC Plastic Trim

Strong Gripping Tongue

Individual Metal Clips retain a Permanent Grip

Exceptional Bond Surface

EPDM Sponge Rubber Flap

Flap Seal is a flexible PVC trim with a EPDM sponge rubber flap attached to provide a secure seal in a variety of dynamic applications. Recommended temperature rating for general applications: -20°F. through +158°F.

1 Flap Length	2 Trim Series	3 Trim Color	4 Texture	Profile (Approx. full size)	5 Edge Thickness	Leg Length	6 Flap Location	Internal Clip	Example Part Number
5B=1"	100 Series	White	Coarse Pebble Sand	<p>Reference only</p> <p>C Location fits 1/4" Trim only</p>	1/16"	9/16"	A	Alum. Steel	1 Flap Length 2 Trim Series 3 Trim Color 4 Texture 5 Edge Thickness 6 Flap Location
6B=1.75"					3/32"	9/16"			
7B=3"		3/16"	9/16"		E				
8B=1.75"						5/32"	17/32"		
5B=1"	150 Series	Black	Pebble Sand	1/4"	1/2"	C			
5B=1"	1350 Series	White	Pebble Sand	<p>C Location fits 1/4" and above Trim only</p>	1/8"	3/4"	A	Alum.	
6B=1.75"					5/32"	3/4"			
7B=3"		3/16"	23/32"		E				
8B=1.75"		1/4"	11/16"						
5B=1"	1375 Series	Black	Pebble Sand	1/4"	11/16"	C			
				5/16"	21/32"				
				3/8"	5/8"				
				1/2"	19/32"				

HOW TO ORDER

- Determine the **FLAP LENGTH** using column. . . . 1
- Determine the **TRIM SERIES #** using column. . . . 2
- Determine the **TRIM COLOR** using column. . . . 3
- Determine the **TRIM TEXTURE** using column. . . . 4
- Determine the **EDGE THICKNESS** using column. . . . 5
- Determine the **FLAP LOCATION** using column. . . . 6

Typical Applications

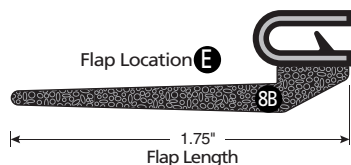
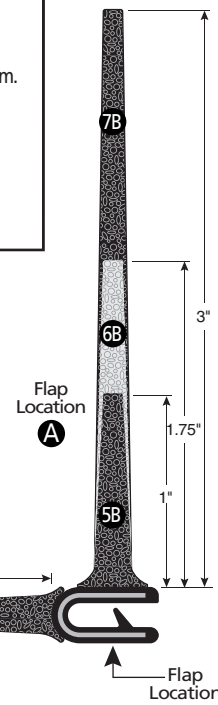
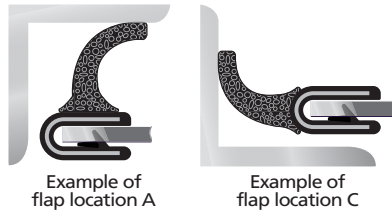

Flap configuration options for 5B, 6B, 7B (Lengths not shown)

To order flaps separately see page 35

LIP GUARD



Lip Guard is a plastic trim with a mylar cover and peel-off tape. This pliable trim comes in chrome and black and has the durability to meet interior or exterior design requirements. Paintable Lip-Guard can be painted to specific color using vinyl base paint.

Many Applications

- Running Boards
- Spas
- Unfinished Edges
- Camper Shells
- Truck Bed Covers
- Fender Flares
- Car Fenders

Product Specifications:

Recommended temperature rating for general applications: -20°F. through +158°F.

Base Material:

Vinyl (PVC)

Decorative Finish:

Mylar Overlay

Adhesive:

3M™ Acrylic Foam Tape with peel-off liner



Lip Guard®	Part No.	Roll Size	Size	Color	Hardness
	LGC	500 ft	7/16"	Chrome	67D
	LGB	500 ft	7/16"	Black	97A
	LGB3/4	500 ft	3/4"	Black	97A
Paintable Lip Guard	Part No.	Roll Size	Size	Color	
	PLGB	500 ft	9/16"	Black	67D
	JLGB	250 ft	1 1/16"	Black	67D

Paintable Lip Guard is...

- Designed to replace the aluminum trim on fiberglass shells
- Can be painted with vinyl based paint
- Designed for camper shells and running boards
 - Pliable and durable to meet exterior design requirements

PLASTIC PROFILES

DRIP RAIL

Drip Rail is a flexible plastic peel 'n stick rain gutter that eliminates time consuming installation of aluminum rain gutters.

- Easy to install with **3M™ Acrylic Automotive Grade Foam Tape**.
- Bonds above windows on your truck, car, RV or boat to channel off water.
- Eliminate streaks from dew and drizzle.
- Control water runoff.

E-Z Peel 'n Stick Rain Gutter with **3M™ Acrylic Foam Tape**

Durable PVC Plastic

Special 'J' design to Channel away water

Product Specifications:

Recommended temperature rating for general applications: -20°F. through +158°F.

Adhesive:

3M™ Acrylic Foam Tape with peel-off liner

Base Material:

Vinyl (PVC), Hardness: 85 Durometer (Shore A)

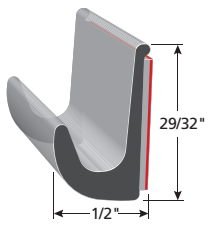
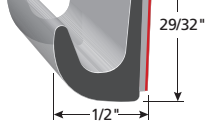
Profile	Part No.	Color
	DRB	Black
	DRW	White



Check out our **How to Install video** at: www.drip-rail-install.info

Custom sizes and colors are available on request. Minimums apply.

CARPET TRIM

Carpet Trim is a flexible PVC trim with a peel and stick carpet edge to prevent carpet frays while providing a finished look.

Product Specifications:

Recommended temperature rating for general applications: -20°F. through +158°F.

Base Material:

Vinyl (PVC)

Finish:

Gloss Black

Adhesive:

3M™ Acrylic Automotive Grade Foam Tape with peel-off liner

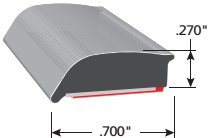
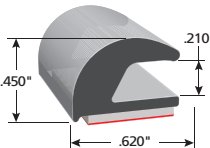
Carpet Trim	Part No.	Size	Color	Hardness
	CP1043	.70	Black	93A
	I11134	.620	Black	85A



PACKAGING OPTIONS

REDI-STIK



Redi-Stik is a flexible plastic trim with a decorative mylar cover. This versatile trim gives an elegant, polished appearance. It comes in two sizes and various colors.



PLASTIC PROFILES

Product Specifications:

Recommended temperature rating for general applications: -20°F. through +158°F.

Base Material:

Vinyl (PVC)

Decorative Finish:

Mylar Overlay

Adhesive:

3M™ Acrylic Foam Tape with peel-off liner

Redi-Stik®	Part No.	Size	Color	Hardness
	RSC5/16 RSB5/16	5/16"	Chrome Black	96A 96A
	RSC7/16 RSB7/16	7/16"	Chrome Black	96A 96A
	CP1155	1 1/4"	Black	67D

Minimums may apply.

SNAP-IN SEAL SYSTEM FOR RV SLIDE OUTS

PATENTED DESIGN!

Our patented "all-in-one" living hinge Snap-In Slide Out Seal System combines a 3-ribbed bulb seal and flap into one design.

3M™ Acrylic Plus pressure sensitive adhesive is utilized as an installation aid and water barrier.

Installation is quick and easy – Stick, Staple & Snap-In to close!

SNAP-IN SINGLE FLAP

Part Number	Flap Length (A)
I11213-1.750	1.750"
I11213-2.000	2.000"
I11213-2.375	2.375"
I11213-2.875	2.875"

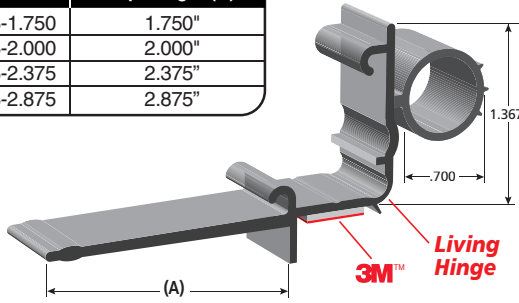

A

Suggested Locations
A B C

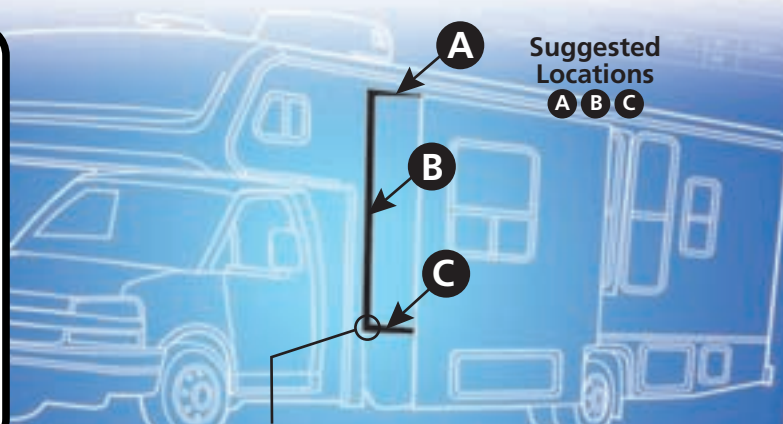

Universal Corners Available Upon Request

SNAP-IN DUAL FLAP

Part Number	Flap Length (A)	Wall Width (B)
I11233-1.750	1.750"	1.875"
I11233-2.000	2.000"	
I11233-2.375	2.375"	
I11233-2.500	2.500"	
I11282-2.375	2.375"	2.000"
I11281-1.750	1.750"	2.250"
I11281-2.375	2.375"	

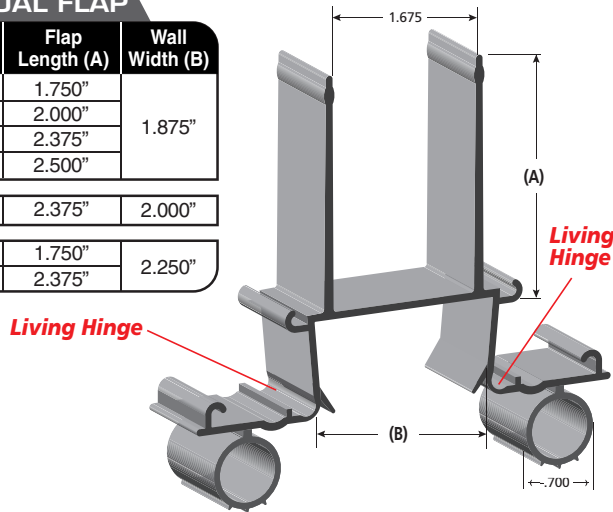

B

ADJUSTABLE SNAP-IN DUAL FLAP

Part Number	Flap Length (A)	Min. Wall Width	Max. Wall Width
I11285-1.750	1.750"	1.25"	2.25"
I11285-2.375	2.375"	1.25"	2.25"
I11285-2.875	2.875"	1.25"	2.25"

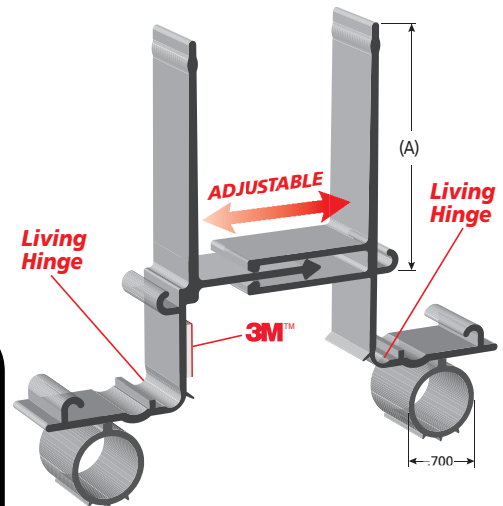

SNAP-IN BOTTOM PAN WITH WEAR BAR

Part Number	Flap Length
I11286-2.00	2.00"

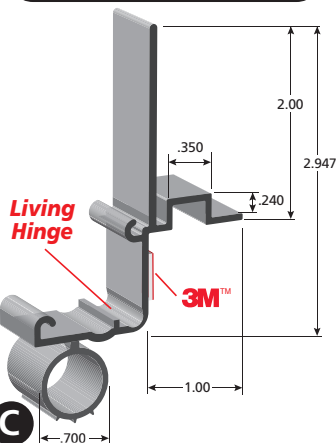

C

SNAP-IN BOTTOM PAN SEAL

Part Number	Flap Length
I11242-2.00	2.930"

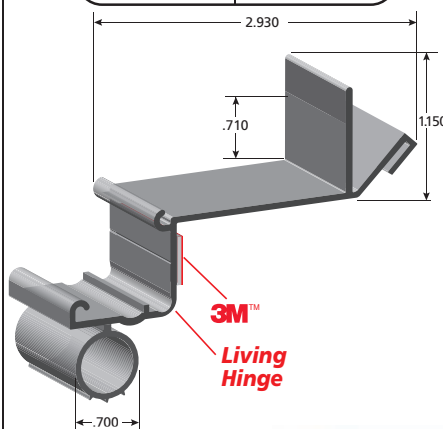

BOTTOM FLAP

Part Number	Flap Length (A)
I11136T-3.00	3.00"
I11136T-3.50	3.50"
I11136T-4.00	4.00"

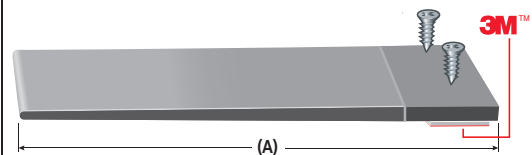

Patent #s:
8,701,351; 8,875,443;
8,910,422

1-888-874-6565
www.trimlok.com

TRIM-LOK INC.

RV APPLICATIONS

RV APPLICATIONS

RV PARTS Trim-Lok has been serving the RV industry at the OEM level as well as the replacement part level for over 40 years.

This page has been created to quickly and easily identify some of the most frequently used parts and some of their applications.

Each part has minimum quantities required at time of order.

VENT SEALS

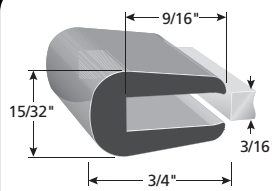

X1013

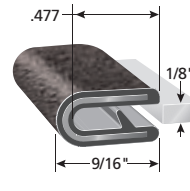

100B3X1/8

ENTRY DOOR SEALS

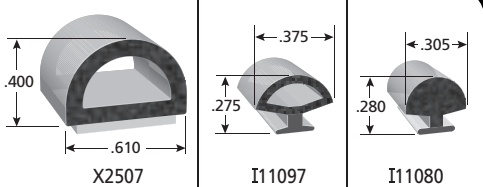

X2507

I11097

I11080

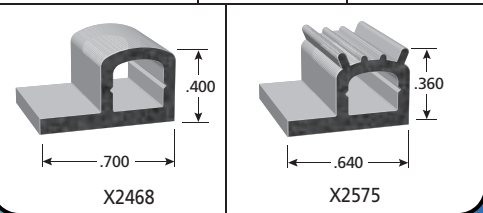

X2468

X2575

FENDER TRIM

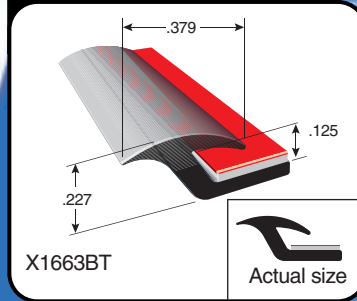

X1663BT

Actual size

Revolutionary Patented Snap-In Seal System!
See Page 27

SLIDE OUT FLAPS

FLAP LENGTH	PART NO.
3.00"	I11136T-3.00
3.50"	I11136T-3.50
4.00"	I11136T-4.00

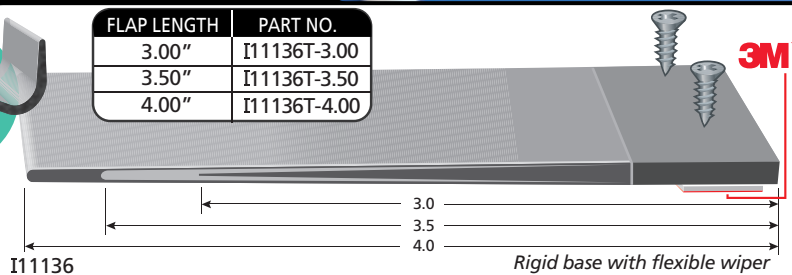

I11136

Rigid base with flexible wiper

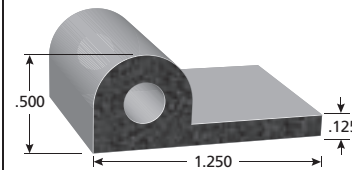

X2199

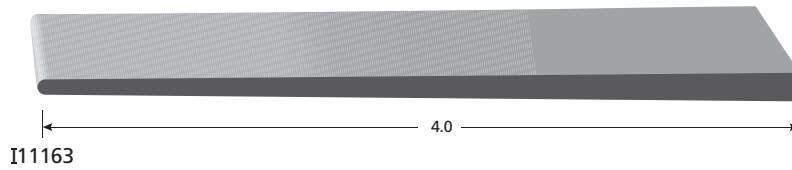

I11163

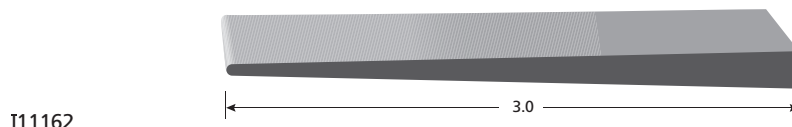

I11162

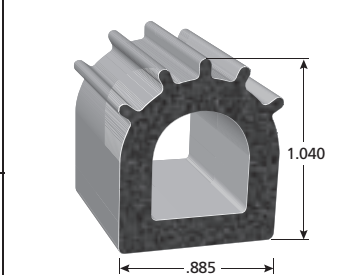



X2828

PROPRIETARY NOTICE
THIS DOCUMENT CONTAINS PROPRIETARY INFORMATION AND ALL INFORMATION HEREIN IS THE PROPERTY OF TRIM-LOK INC. PERMISSION IS GIVEN TO REPRODUCE THIS DOCUMENT FOR YOUR OWN USE ONLY. ANY OTHER REPRODUCTION OR USE OF THIS INFORMATION WITHOUT WRITTEN AUTHORIZATION FROM TRIM-LOK INC. IS PROHIBITED.

RV APPLICATIONS

RV APPLICATIONS

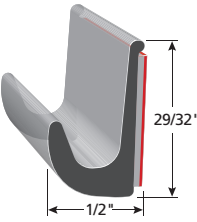
DRIP RAIL

Profile	Part No.	Color
	DRB	Black
	DRW	White

SCREW CAP COVERS

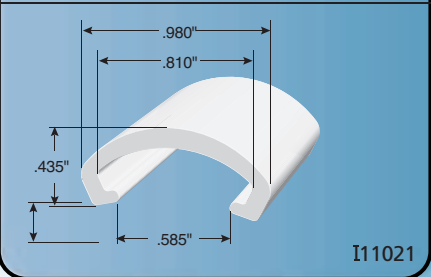
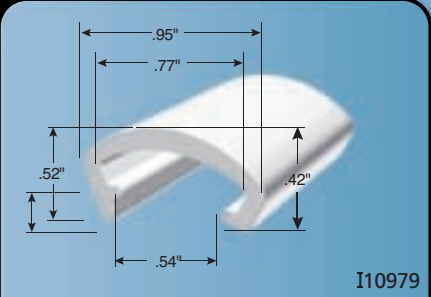

WINDOW SEALS

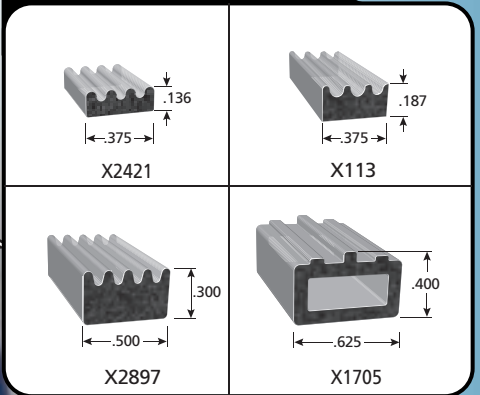

BAGGAGE DOOR TRIM SEALS

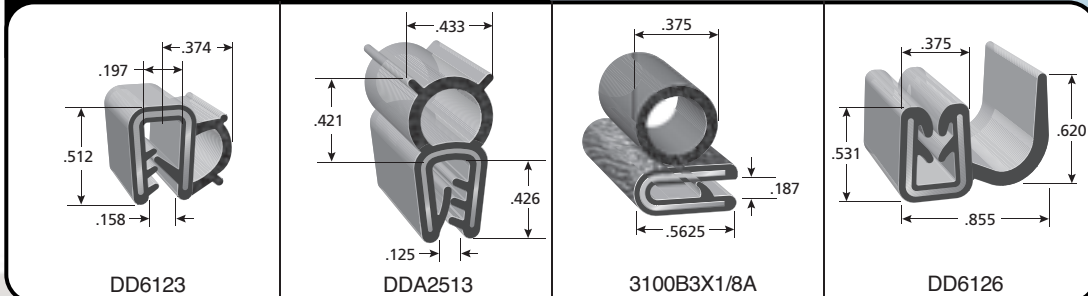

RUBBER SEAL



SEALS



Ozone Resistant
EPDM Rubber

Pressure Sensitive
Adhesive (PSA) Tape
with Peel-Off Liner

For the Best Tape Fit
See Page 42

FOR A WATER
TIGHT SEAL!



Rubber Seals come in a variety of specially designed shapes, made from custom formulated EPDM closed cellular sponge.

RUBBER SEAL DISCLAIMER: Due to a constant effort to update our Rubber Seal products, specifications are subject to change without notice and without incurring obligation. Because we cannot anticipate or control the many different conditions which this information and our products may be used, Trim-Lok does not guarantee the applicability, accuracy or the suitability of a product in any given situation. Users should conduct their own tests to determine the suitability of each product for a particular application. The products described here are sold without warranty either expressed or implied and the buyer assumes all responsibility for loss or damage arising from the handling and use of our products.

CLEANING AND APPLICATION INSTRUCTIONS

Regardless of bonding surface, it must be clean and free of surface contaminants such as oil, grease, mold release and dirt. Most bonding failures are due to improperly cleaned surfaces. Prior to applying any adhesive, clean surface with 50/50 isopropyl alcohol and water solution.



Product Specifications:

Recommended temperature rating for general applications:
-20°F. through +158°F.
(EPDM)

Application:

For optimum performance use
25% - 40% maximum compression
with 25% being optimum.

Resistance Ratings:

Excellent resistance to water absorption, ozone, sunlight aging, low temperature, and compression set.

Flammability and Code Compliance:

FMVSS 302
UL 50E
UL 94HB



1-888-874-6565
TRIM-LOK® INC.
www.trimlok.com

RUBBER SEAL

Part Number Example

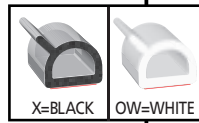

Color **1**
Tape Option **3**
2 Rubber Seal Profile
4 SINGLE (If Applicable)

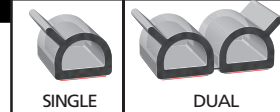

Single and Dual Option

Tape Options:
NT = No Tape
HT = General Acrylic PSA
BT = **3M**™ Bonded Tape System

"D" SECTIONS

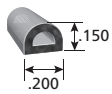

X2476

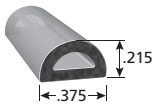

X1333

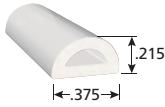

OW1333

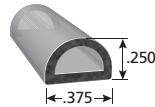

X1153

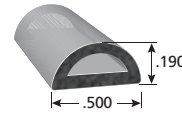

X1543

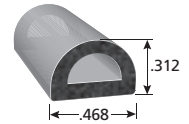

X110

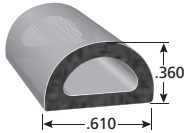

X109

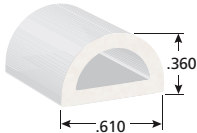

OW109

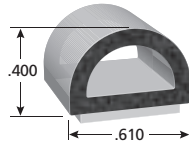

X2507

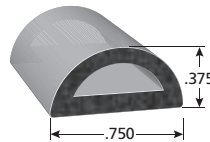

X119

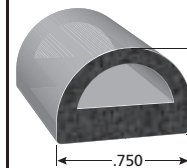

X125

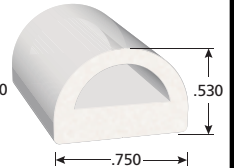

OW125

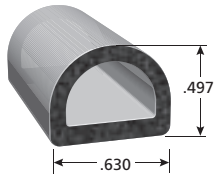

X2373

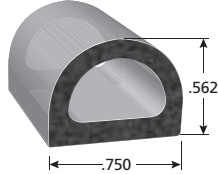

X135

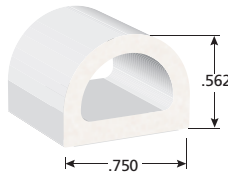

OW135

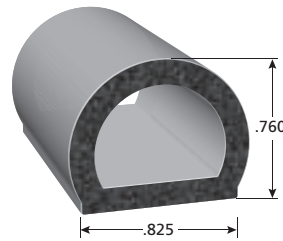

X1750

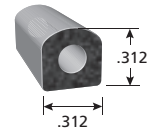

X2576

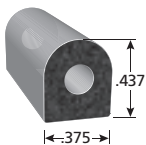

X105

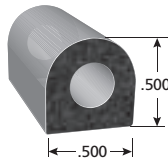

X202

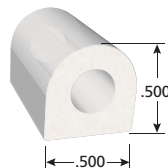

OW202

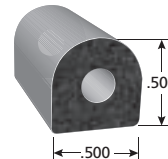

X101

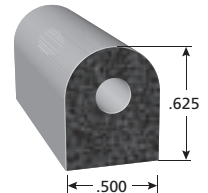

X2338

See page 42 for tape options

RUBBER SEAL

Part Number Example

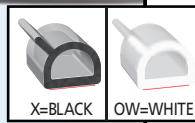

1 Color
2 Rubber Seal Profile
3 Tape Option
4 SINGLE (If Applicable)

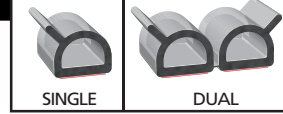

Single and Dual Option

Tape Options:
NT = No Tape
HT = General Acrylic PSA
BT = 3M™ Bonded Tape System

"D" SECTIONS

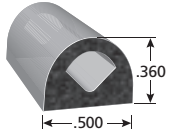

X108

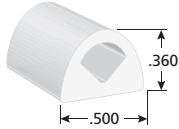

OW108

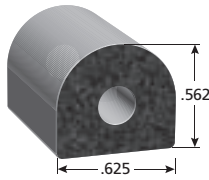

X2012

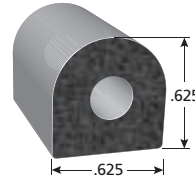

X5381

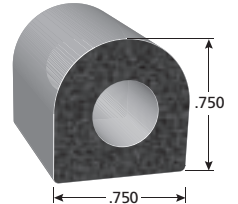

X1458

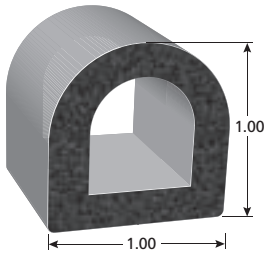

X5272

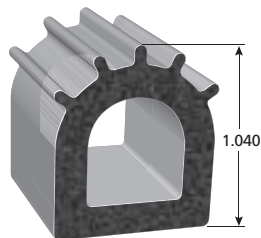

X2828

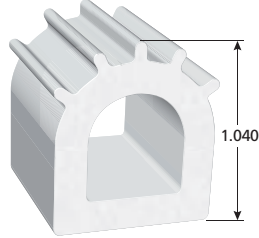

OW2828

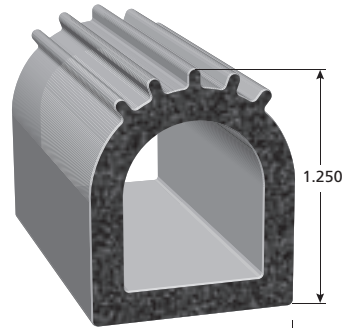

X2492

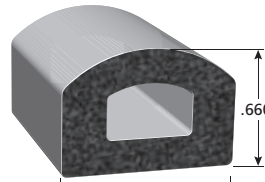

X1613

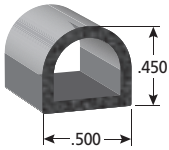

X2705

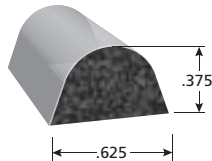

X2471

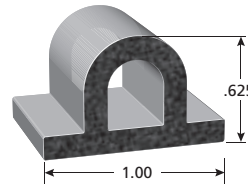

X1712

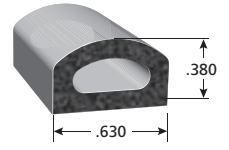

X1524

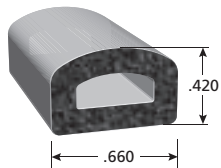

X2463

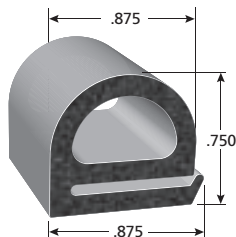

X1921

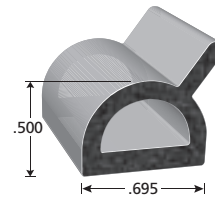

X5036

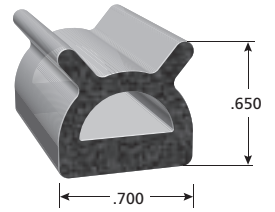

X2354

RUBBER SEAL



SEALS

TRIANGLE SECTIONS

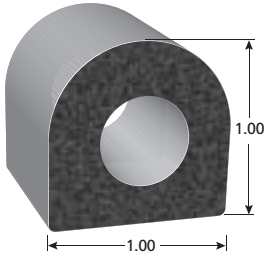

X1678

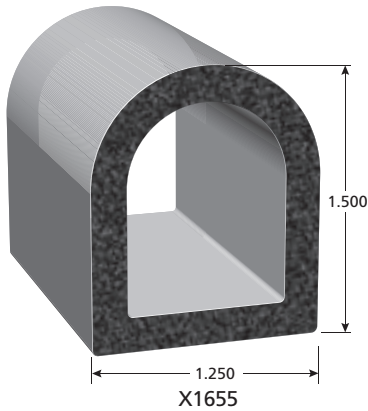

X1655

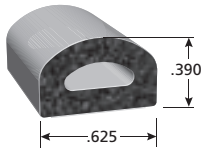

2495

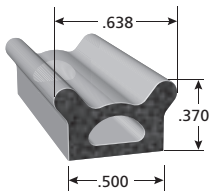

X2337

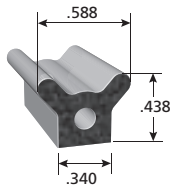

X2529

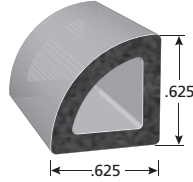

X2123

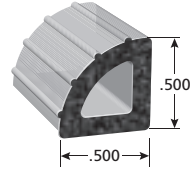

X2532

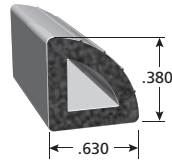

X2025

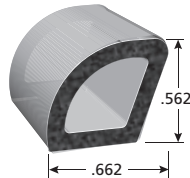

X1711

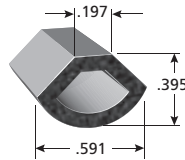

X1923

Adhesive Options – Choose the tape that fits your needs

"HT" GENERAL PURPOSE PRESSURE SENSITIVE ADHESIVE

This acrylic based adhesive is best used to hold the rubber seal in place while installed in a static application or compressed between two stationary objects. May be used in some light duty dynamic applications against a variety of substrates. Good heat performance -20°F. to +158°F.

Please Note: During application ambient temperature must be above 60° F.

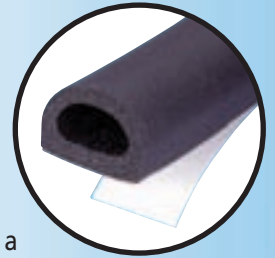

"BT" 3M™ HIGH STRENGTH TAPE SYSTEM

The ultimate bond between the rubber and substrate. Creates a moisture barrier and air tight seal between rubber and substrate. Highest peel and shear resistance, can be used under high loads of stress and force. Has low initial tack for easy re-positioning during installation and requires 72 hours of cure time for full bond strength. Good heat performance -20°F. to +158°F.



Check out our
How to Install video at:
www.rubber-seal-install.info

PEDESTAL SEALS

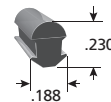

DD6109

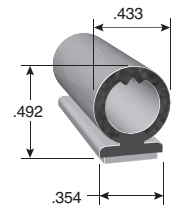

DD1604

See page 42 for tape options

RUBBER SEAL

"P" SEALS

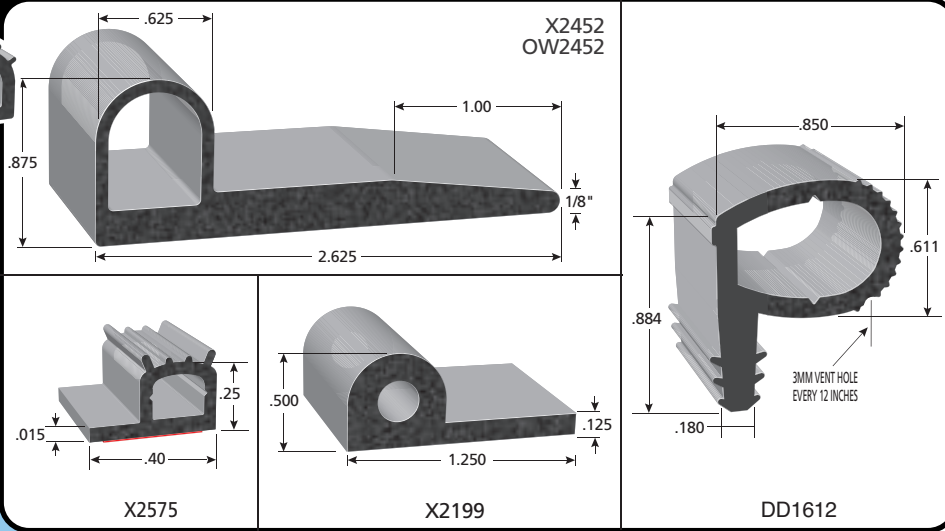

LID SEALS

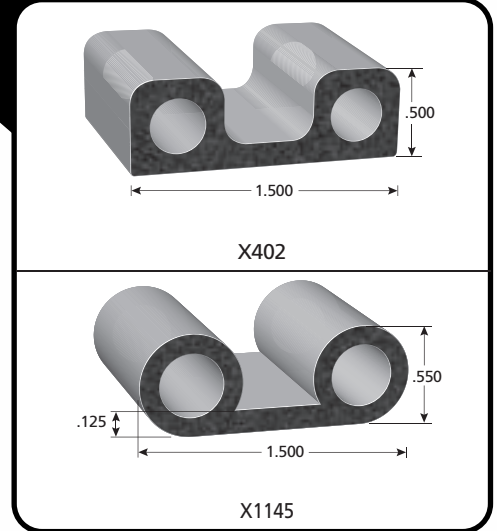

FENDER FLARE TRIMS

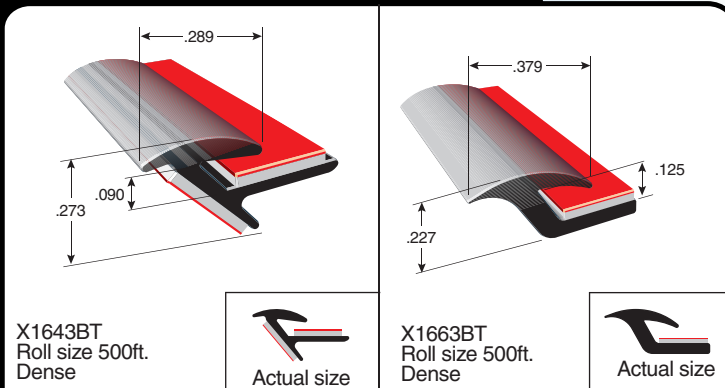

Fender Flare Trim is an ozone resistant EPDM rubber that mounts between the flare and the body. **3M™** automotive grade tape creates a solid bond between both surfaces.



Easily installed before fender flare is installed against body to isolate vibration and provide an attractive finish.



ADDITIONAL PROFILES

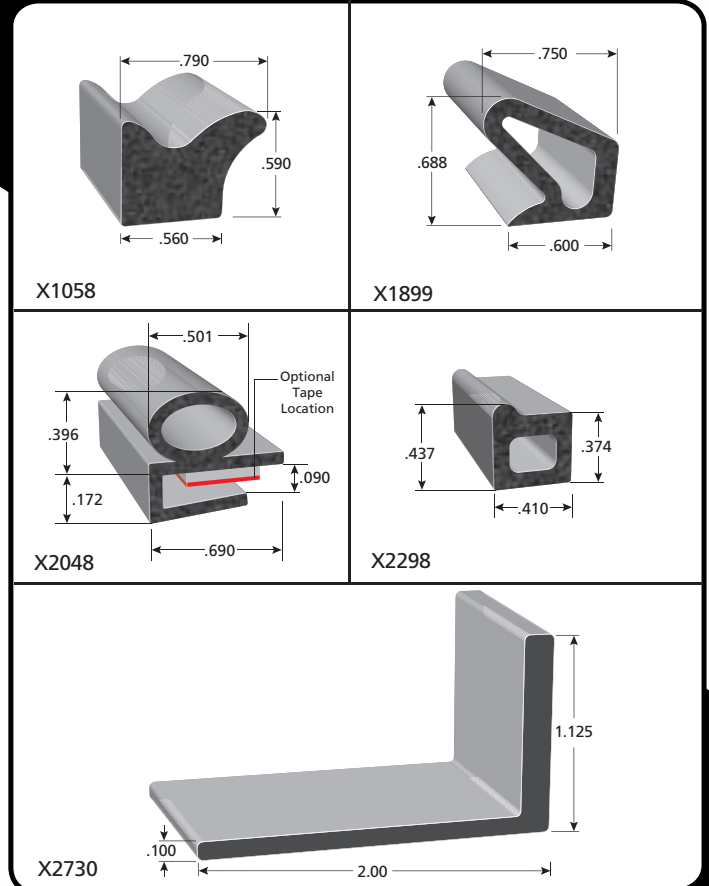

See page 42 for tape options

1-888-874-6565

TRIM-LOK INC.
www.trimlok.com

RUBBER SEAL

Part Number Example

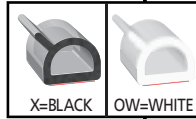

Color **1** Tape Option **3** **4**
X105 BT SINGLE
 (If Applicable)
2
 Rubber Seal Profile

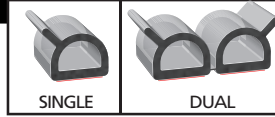

Single and Dual Option

Tape Options:
 NT = No Tape
 HT = General Acrylic PSA
 BT = 3M™ Bonded Tape System

RIBBED SECTIONS

 X2421	 X1568	 X2266	 X113 OW113	 X1698
 X103	 X2897	 X1621	 X376	 X112
 X114 OW114	 X1705	 X2469		

FLAP SECTIONS

 X2877	 X2248 EPDM Dense
 8B	 X2045 EPDM Dense
 5B	 X2064 EPDM Dense
 6B	 7B

See page 42 for tape options



RUBBER SEAL

CORNER GUARD

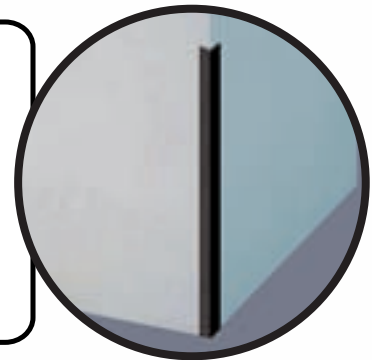
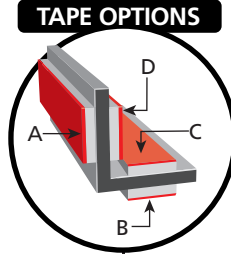
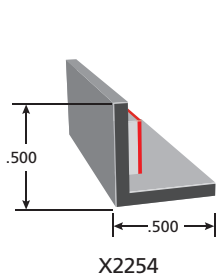

See page 42 for tape options

SPLICE CORD & WELTING

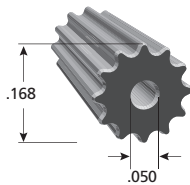
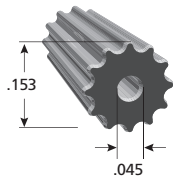

Profiles shown not to scale

TUBING AND CORD

SOLID ROUND

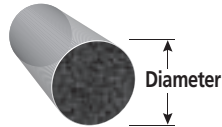

Part#	Diameter
X301	.250"
X303	.375"
X305	.500"
X307	.625"

TUBING

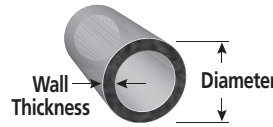

Part#	Diameter	Inside Dim.	Wall Thickness
X310	.236"	.174"	.031"
X311	.275"	.206"	.035"
X313	.375"	.280"	.050"
X315	.437"	.364"	.058"
X317	.625"	.474"	.078"
X319	.750"	.564"	.093"
*X321	1.00"	.075"	.125"

* These parts sold in 500 foot increments except X321 (125ft.)

SOLID RECTANGLE

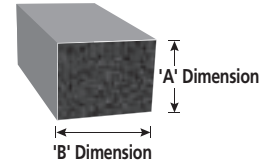

Part#	'A' Dim.	'B' Dim.
X272	.250"	.500"
X273	.375"	.500"
X274	.250"	.750"
X275	.500"	.750"
X1449	.750"	.375"
X1450	.750"	.125"
X268	.250"	.250"

FOR A WATER TIGHT SEAL!



Part Number Example

Color: X=BLACK, OW=WHITE

Tape Option: 1 (Color), 2 (Rubber Seal Profile), 3 (Tape Option), 4 (Single/Dual)

Example: X105 BT SINGLE (If Applicable)

Single and Dual Option

Tape Options:
 NT = No Tape
 HT = General Acrylic PSA
 BT = 3M™ Bonded Tape System

PACKAGING OPTIONS



OPTION 1

These boxes are designed to allow the customer to feel the part while still preserving the integrity of the packaging. This option also has a foldable tab allowing them to be hung on a peg or stacked on a shelf.

<p>100B3X1/8</p>	<p>100W3X1/8</p>	<p>X113HT Dual 500 ft.</p>
<p>X1333HT</p>	<p>X202HT</p>	<p>X135HT</p>

AM100B3X1/8-25	25 packs of 100B3X1/8	(25 feet)
AM100W3X1/8-25	25 packs of 100W3X1/8	(25 feet)
AMX113HT-50	25 packs of X113HT	(50 feet)
AMX202HT-25	25 packs of X202HT	(25 feet)
AMX1333HT-50	25 packs of X1333HT	(50 feet)
AMX135HT-10	25 packs of X135HT	(10 feet)

OPTION 2

This packaging option is a hangable poly bag that secures and protects the parts. This option is also available in for those customers that need a private label attached.

Hanging Polybag Option



<p>AMHC-100B3X1/16-25</p>	<p>AMHC-100B3X3/16-25</p>
<p>AMHC-12B100B7X3/16C-25</p>	<p>AMHC-4100B3X1/16C-25</p>

Minimums and lead times may apply.

LOCKING GASKET



SEALS

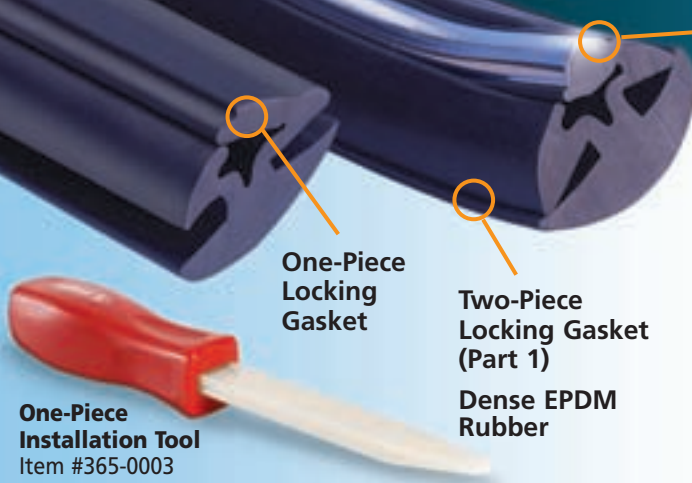

One-Piece Installation Tool
Item #365-0003

Locking Gasket is an EPDM dense rubber extrusion designed to lock in the installation of stationary windows or windshields. Locking Gaskets provide a secure seal between a metal or fiberglass body panel and a glass or plexiglas window. Available in one-piece and two-piece styles with a locking key, and are highly resistant to numerous environmental conditions. Slip coating available upon request.

- Resistance to Ozone — Excellent
- Water Absorption — Excellent
- Sunlight Aging — Excellent
- Low Temperature — Excellent
- General Temperature Rating -40°F. to + 212°F.
- Flammability and Code Compliance — FMVSS 302

ONE-PIECE LOCKING GASKETS

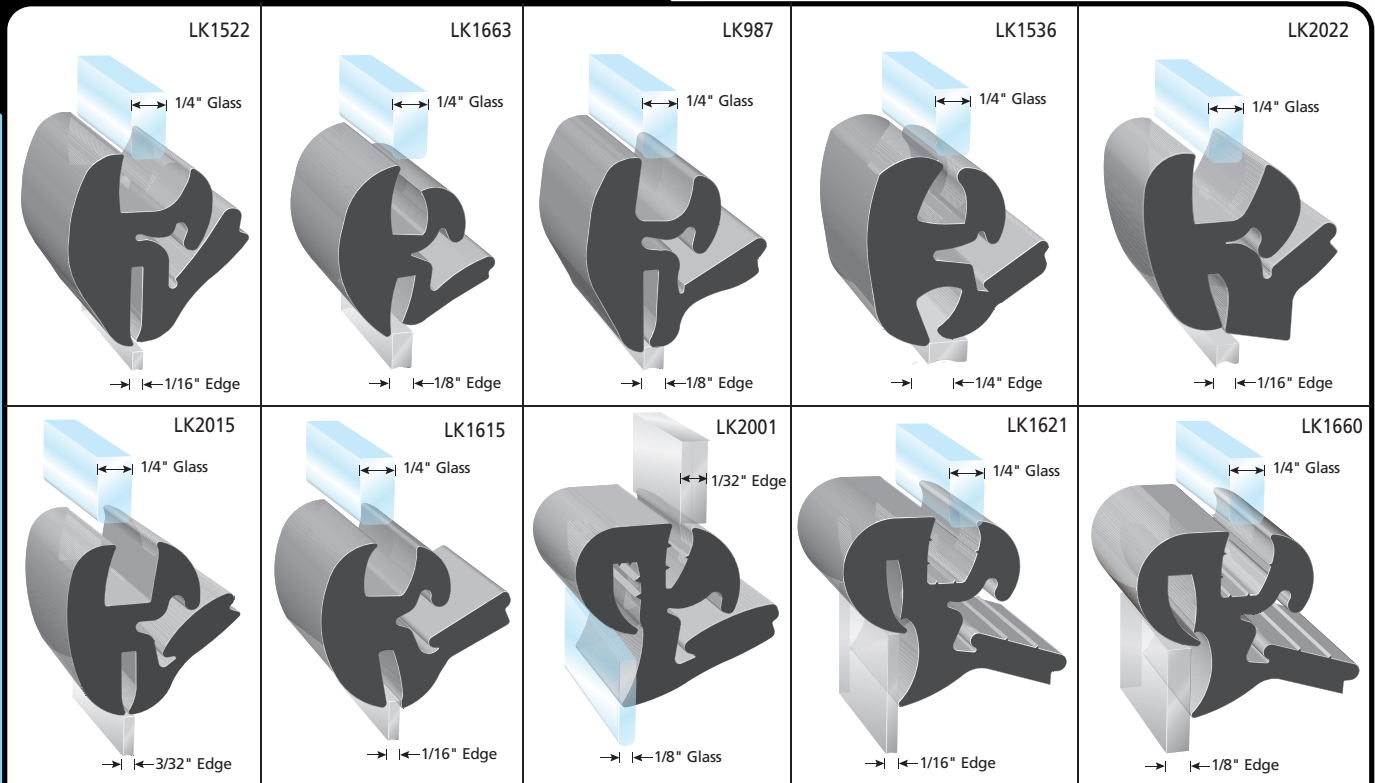

	Part Number	Glass Panel Thickness	Body panel thickness	**Minimum recommended clearance between glass and edge	Overall Height	Minimum recommended radius of panel opening	Weight per foot
<p>** Minimum Recommended Clearance</p>	LK1522	0.1875" - 0.250"	0.035" - 0.067"	0.301"	1.07"	2.50"	0.275 lbs.
	LK1663	0.1875" - 0.250"	0.09" - 0.14"	0.220"	0.90"	2.00"	0.196 lbs.
	LK987	0.1875" - 0.250"	0.09" - 0.14"	0.265"	1.07"	2.50"	0.246 lbs.
	LK1536	0.1875" - 0.250"	0.1875" - 0.25"	0.406"	1.09"	3.50"	0.225 lbs.
	LK2022	0.250" - 0.313"	0.04" - 0.08"	0.280"	0.970"	2.50"	0.323 lbs.
	LK2015	0.200" - 0.250"	0.075" - 0.095"	0.260"	0.95"	2.50"	0.236 lbs.
	LK1615	0.1875" - 0.250"	0.06" - 0.09"	0.300"	0.906"	2.50"	0.275 lbs.
	LK2001	0.120" - 0.140"	0.030" - 0.060"	*0.160"	1.00"	2.50"	0.286 lbs.
	LK1621	0.1875" - 0.250"	0.046" - 0.075"	*0.140"	0.937"	2.00"	0.26 lbs.
	LK1660	0.1875" - 0.250"	0.075" - 0.140"	*0.140"	1.00"	2.50"	0.293 lbs.

* Offset dimension between glass and body panel.

LOCKING GASKET

INSTALLATION

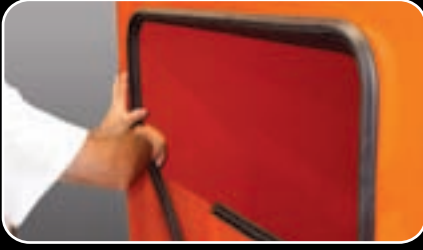

1. Secure Locking Gasket to body panel.



2. Lubricate Locking Gasket. Then slide glass in bottom first.



3. Finish working rubber around glass with tools found on pages 40-41.

Check out our How to Install video at: www.locking-gasket-install.info



SEALS

TWO-PIECE LOCKING GASKETS

Part 1

LK1035

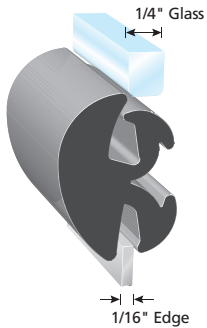

LK1179



LK1488



LK1456



LK1696



Part 2 LOCKING KEY OPTION

Installed Profile Example

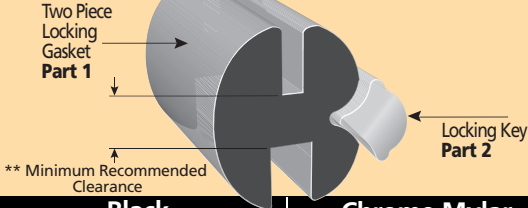

Black Locking Key

Chrome Mylar Locking Key

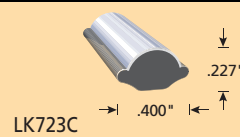

LK1573

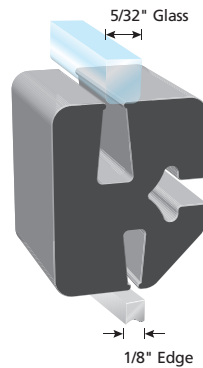

LK2016



LK2004

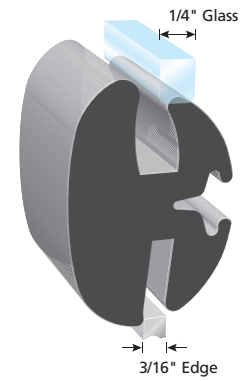

Part Number	Glass panel thickness	Body panel thickness	**Minimum recommended clearance between glass and edge	Overall Height	Minimum recommended radius of panel opening	Weight per foot	Matching black locking key part number (part 2)	Matching chrome locking key part number (part 2)
LK1035	0.1875" - .250"	0.050" - .095"	0.23"	0.85"	2.25"	0.155 lbs.	LK937	LK723C
LK1179	0.1875" - .250"	0.093" - .140"	0.30"	1.10"	2.5"	0.277 lbs.	LK937	LK723C
LK1488	0.1875" - .250"	0.1875" - .250"	0.30"	1.00"	3.5"	0.202 lbs.	LK937	LK723C
LK1456	0.1875" - .250"	0.175" - .188"	0.30"	0.95"	2.0"	0.198 lbs.	LK937	LK723C
LK1696	0.1375" - .250"	0.175" - .188"	0.260"	0.95"	2.0"	0.193 lbs.	LK937	LK723C
LK1573	0.125" - .187"	0.100" - .140"	0.246"	0.961"	4.0"	0.289 lbs.	LK937	LK723C
LK2016	0.180" - .220"	0.100" - .130"	0.265"	1.29"	4.0"	0.358 lbs.	LK937	LK723C
LK2004	0.180" - .220"	0.09" - .125"	0.35"	1.07"	2.5"	0.241 lbs.	LK937	LK723C

See page 40-41 for more information on Locking Gasket installation tools.

TOOLS AND ACCESSORIES

(A) Instant Adhesive

A superior adhesive bond on "hard to glue" surfaces that creates a secure seal on corners and joints. It protects TRIM-LOK products against harsh conditions by bonding ends securely. This product bonds rubber, plastic, fiberglass, metal, wood, paper, leather, and foam. It cures in 0 - .25 seconds with a temperature rating of 20°F. to +150°F., with full cure in 24 hours.

.7 oz (20g per bottle)
STOCK #4401TL

(B) Straight Edge Clipper

A compact hand-held tool that creates a professional appearance on most applications. Product comes with 2 replacement blades.

(2 blades/pkg.)

STOCK #WCSC1

Replacement Blades #RBA

(C) EC-1 Tool

General purpose cutter.
STOCK #EC-1

(D) Handheld Roller

A handheld roller to assist with the correct application pressure needed for all Rubber Seal adhesives.

STOCK #HR-1

(E) Ball End Tool for 1-piece Locking Gasket

This tool has a small, round steel ball on the end. Once the steel ball is inserted down into the rubber gasket, it is very difficult for it to come out. If it should slip out of the gasket, there is less of a chance you will scratch the paint of the vehicle you are working on.

STOCK #365-0007

(F) Lock Strip Insertion Tool

Features off-set handle to keep hands away from glass and two double end tips that will fit most applications. The unique design allows the tip to swivel 90 Degrees. Intended for 2-piece locking gaskets.

STOCK #365-0008

(G) Plastic Installation Tool

Specifically designed to ensure a safe, easy, and efficient installation of one piece Locking Gaskets for stationary windows and other glass applications.

STOCK #365-0003



ACCESSORIES



(H) Rubber Seal 90° Miter Tool
 Heavy-duty construction provides clean, 90° miter cuts with minimal effort. Blade opens .460". Larger rubber seal parts may be cut by compressing the overall height.

STOCK# GS849RS

Blade Replacement #GS848RS

(I) 90° Miter Tool

A perfect miter with the close of your hand! This tool is designed to miter, notch or trim a variety of materials, including metals, plastics, and mitering metal core trim. Blade opens .25".

STOCK #GSS851

Blade Replacement #GS850

(J) Locking Gasket Tool Kit

Specifically designed to ensure a safe, easy and efficient installation of Locking Gaskets for stationary windows and other glass applications.

STOCK #365-0000

(K) Pneumatic Hammer

This palm size pneumatic hammer applies trims and seals where speed and high volume installations are essential. This product eliminates the need for a variety of cumbersome hammers and mallets.

STOCK #AH-1

O-Ring Replacement Kit #AS-OK-151
 Tip #AH-T-15-SS

(L) Gasket Rope Insert Tool

This handy gasket rope insert tool is designed to ease the rope under the lip and seat it in the groove of the gasket. It comes with a sturdy 20 foot rope.

STOCK #365-0005

(M) Pigtail Tool for 1-piece Locking Gasket

It can be difficult to fold the self-locking rubber into the locking part. This tool solves this problem by rolling the locking lip into the body easily.

STOCK #365-0006

(N) Double Bend Rubber Hook Tool

Designed for pulling the rubber gasket over the pinchweld on rubber set jobs. Has a bent-then-curved end. Shank measures 3-1/4".

STOCK #365-0004



ACCESSORIES

Utilizing the Right Material

EPDM (Ethylene-Propylene-Diene-Monomer) is well known for its excellent ozone, weathering and aging resistance. It also has excellent water and steam resistance, maintains its flexibility at low temperatures, features excellent resistance to alkalis, acids and oxygenated solvents, and is very color stable. It is not recommended for resistance to oil, gasoline and hydrocarbon solvents. EPDM is found in a wide range of applications and is excellent for outdoor use.

Neoprene (Polychloroprene) has moderate resistance to oils and gasoline. It features good flame resistance, weathers well and has very good resistance to abrasion, flex cracking, alkalis and acids. However, expect poor resistance to aromatic and oxygenated solvents and limited flexibility at low temperatures. Neoprene is generally considered an excellent all-purpose elastomer with a solid balance of properties and few limitations.

Nitrile (Acrylonitrile-Butadiene) has very good oil and abrasion resistance to alkalis and acids. Nitrile must be specially compounded for resistance to ozone, sunlight and natural aging. It has poor resistance to oxygenated solvents. Nitrile is superior to neoprene in oil and solvent resistance, but is not recommended for applications where it is exposed to severe weathering.

Nitrile PVC provides premium performance and long-term reliability in very harsh and corrosive environments. Has exceptional resistance to heat aging and a broad range of fuels, solvents and chemicals makes it ideal for many demanding aerospace, automotive and industrial applications. Fluoroelastomers also offer excellent resistance to weather, ozone, oxygen and sunlight, and are inherently more flame retardant than hydrocarbon rubbers. Fluoroelastomers have poor resistance to ketones, ester, ethers, amines and aqueous bases (e.g., ammonia and sodium hydroxide).

TPE (Thermoplastic Elastomers) are materials that have the properties and performance of rubber, but are processed like thermoplastics. Performance properties are similar to conventional thermosets such as EPDM or neoprene. TPE has good direct flame resistance as well as aliphatic and aromatic hydrocarbon solvents, oil and gasoline.

PVC has excellent impact strength, good resilience, tensile strength, abrasion resistance and maintains flexibility at lower temperatures. It is not the polymer of choice when resistance to oil, gasoline and hydrocarbon solvents is required.

Silicone Rubber offers good resistance to extreme temperature, being able to operate normally from -50°F. to 500°F.+ while retaining flexibility. And, at extreme temperatures, silicone's tensile strength, elongation, tear strength and compression set can be far superior to conventional rubbers.

CLEANING AND APPLICATION INSTRUCTIONS

Regardless of what bonding surface you apply the gasket to, it must be clean and free of surface contaminants such as oils, greases, mold releases and dirt in general. Most bonding failures are not due to the adhesive failing but, instead the failure to properly clean the surfaces. Prior to applying any of these adhesives, clean surface with 50% denatured alcohol and 50% water solution.

Choosing the Right Adhesive

ADHESIVE OPTIONS

BT 3M™ BONDED TAPE SYSTEM

The ultimate bond to the rubber and the ultimate bond to the substrate. Specifically designed to perform in dynamic applications, this engineered tape system creates a moisture barrier and air tight seal between rubber and substrate. Highest peel and shear resistance, low initial tack for easy repositioning during installation and needs 72 hours of cure time to come to full bond strength. Good heat performance -20°F to +158°F.

ADHESIVE CROSS SECTION

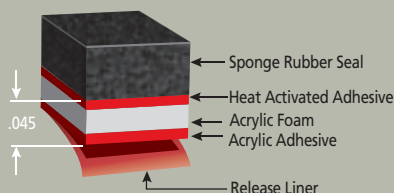

HT STANDARD PRESSURE SENSITIVE ADHESIVE

This acrylic based adhesive is best when used to hold the rubber seal in place in a static application or compressed between two stationary objects. May be used in some light duty dynamic applications against a variety of substrates. Good heat performance -20°F to +158°F.

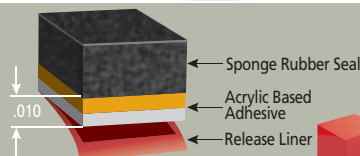

HTR HIGH TACK PRESSURE SENSITIVE ADHESIVE

This rubber based adhesive is best when used to hold the rubber seal in place while installing in static applications or compressed between two stationary objects. HTR has better initial tack as well as adhering to some difficult bond surfaces such as polypropylene and polyethylene. Heat limitations -20°F to +130°F.

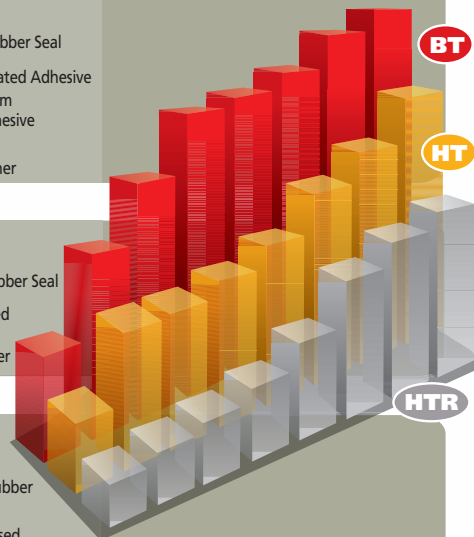
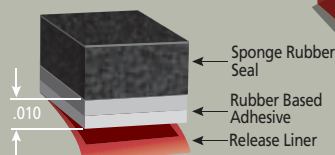

1-888-874-6565

TRIM-LOK INC.
www.trimlok.com

Trim-Lok's Quality is First!

Since 1971 customer satisfaction has been our number one priority. Our objective is to ship quality and reliable products to all of our valued customers. Our goal is to maintain a Quality Management System that meets or exceeds the requirements of ISO/TS 16949 and ISO 9001.

Trim-Lok's Service

Trim-Lok's Mission is "To be the leader and trusted supplier of choice for innovative Trim and Seal solutions." With over 40 years of consistent growth Trim-Lok has proven to its customers that premier customer service and quality is the priority. Trim-Lok has provided support to their customers by shipping on time for both off-the-shelf and custom extruded parts.

Trim-Lok Custom Fabricated Solutions

Trim-Lok brings the most experienced team in the industry toward the development of custom fabricated solutions across all of the industries it serves. Trim-Lok's product development assistance unifies industrial design, engineering rigid prototyping and manufacturing to serve their customers. Trim-Lok's product development team brings high caliber mechanical design, excellent materials knowledge, and strong manufacturing expertise. All of our processes involve continuous improvement and our employees are recognized for their contributions to this end. All aspects of Trim-Lok from custom design to engineered solutions to on-time deliveries are centered around our highest priority – Keeping our customers satisfied.

TRIM-LOK'S CAPABILITIES & DELIVERABLES

MATERIALS

Rubber

- EPDM (Ethylene-Propylene-Diene Monomer)
 - Sponge and various durometers of Dense
- Nitrile (BUNA-N) - Dense
- Nitrile PVC (N/PVC) - Sponge
- Neoprene (CR, Polychloroprene)
 - Sponge and various durometers of Dense
- Silicone (SI) - Sponge and various durometers of Dense

Plastic

- TPE, TPO, TPR, TPU, TPV
- PVC - Flame Resistant
- PVC - Flexible and Rigid
- Polyethylene (HDPE, LDPE, LLDPE)
- Acrylonitrile-Butadiene-Styrene (ABS)
- Polypropylene
- Polycarbonate

- Single and Co-Extrusions
- High Tolerance Splicing
- Plastic Welding
- Pressure Sensitive Adhesives
- Continuous or Cut to Length
- Custom Design/Profile
- Custom Kit Assemblies
- Private Label Packaging
- Custom Color Matching
- Notching
- In-line Printing
- Mitered Corners and Frame Assemblies
- Hot Bonded Corners
- Cold Bonded Corners
- Injection Molded Corners
- Film Splicing
- Drilling / Punching
- Decorative Mylar Application
- Slip Coating

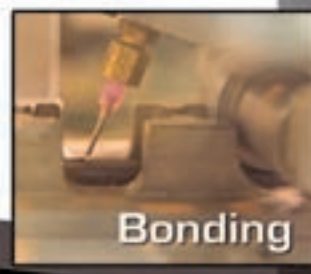
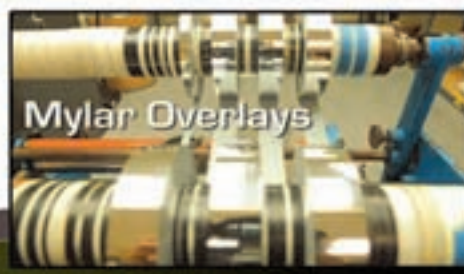
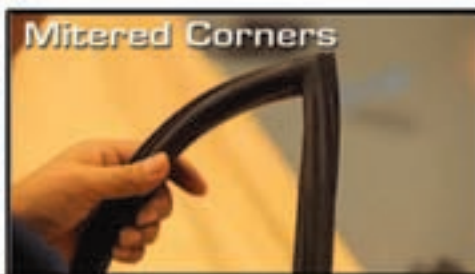

MATERIALS EXPERTS IN:

RUBBER

EPDM

NITRILE

NITRILE PVC

NEOPRENE

SILICONE

PLASTIC

TPE, TPO, TPR, TPU, TPV

PVC

POLYETHYLENE

ACRYLONITRILE-BUTADIENE-STYRENE

POLYPROPYLENE

POLYCARBONATE



TRIM-LOK, INCORPORATED LIMITED WARRANTY

Trim-Lok®[®], Inc. warrants all applicable products to be free from defects in material and workmanship for a period of ninety (90) days from date of purchase. This warranty does not include damage to products resulting from accident, misuse, improper installation or storage, and unauthorized alterations.

Trim-Lok's warranty obligation shall be limited to furnishing substitute products for original products, which in Trim-Lok's sole judgement, have proven defective in material or workmanship within the ninety (90) day warranty period.

Any implied warranties of merchantability or propriety for any particular purpose, shall be strictly limited in duration to that of the express warranty set forth above. In no event shall Trim-Lok be liable for any special, incidental or consequential damages resulting from the manufacture, sale, or use of these products under any legal theory. Said damages shall include, but not be limited to, lost profits, damage to property, or damages for personal injury. Trim-Lok's liability shall in no case exceed the price paid for the product claimed to be defective.

RETURNS:

Trim-Lok will not accept returns without prior authorization and an RMA number issued and marked on the return merchandise. Returns may be subject to shipping and restocking charges. Trim-Lok reserves the right to ship and bill up to 10% over and under quantity ordered on all parts.

NOTE:

Some ingredients used in these products, or their component materials, may not be compatible with certain surfaces. These ingredients may cause staining and or other consequential damages.

CATALOG INFORMATION:

The information contained in this catalog is based upon data believed to be accurate. Specifications and products are based upon information at the time of printing and are subject to change without notice and without incurring liability. No guarantee or warranty is made of the catalogs accuracy. Trim-Lok assumes no liability for product failure unless specifically stated in writing by an authorized representative of Trim-Lok. No warranties, expressed or implied, other than Trim-Lok's written limited warranty, will be honored.



TRIM-LOK California • 6855 Hermosa Circle • Buena Park, CA • 90622-6180 TRIM-LOK Midwest • 1642 Gateway Ct. • Elkhart, IN • 46514

Toll Free: 1-888-TRIM-LOK (874-6565)

(714) 562-0500 • FAX: (714) 562-0600 • E-Mail: info@trimlok.com • Website: www.trimlok.com

©2017 Trim-Lok, Inc. All rights reserved.